

1974 | 2024

50

YEARS

SUSTAINABLE
QUALITY

kranzle[®]

MADE IN GERMANY



PRODUCT CATALOG

HIGH-PRESSURE CLEANERS | VACUUM CLEANERS | POWER SWEEPERS



SALES AND SERVICE POINTS

In addition to first-class product quality, we also provide professional advice and offer a dedicated service, through our Kränzle partners worldwide.

GENERAL GUIDELINES

This product catalog is valid from 1st May 2024. All previous product catalogs are no longer valid. Technical changes and errors reserved. The general terms and conditions of **Josef Kränzle GmbH & Co. KG** apply.

kränzle[®]

Josef Kränzle GmbH & Co. KG

Rudolf-Diesel-Straße 20
89257 Illertissen (Germany)
www.kraenzle.com

SALES

phone sales: +49 (0) 7303 96 05-250
fax: +49 (0) 7303 96 05-670
mail: sales@kraenzle.com



[youtube.com/kraenzleDE](https://www.youtube.com/kraenzleDE)

TABLE OF CONTENTS



Kränzle Introduction - 50 Years Sustainable Quality	6-7
Key industries.....	12-13
Digital Product Advisor.....	14
Quality in every detail.....	16-17

COLD WATER HIGH-PRESSURE CLEANERS

COLD WATER - COMPACT

HD-Series	20-23
K 1152-Series	24-25
X-Series	26-27
K 2000-Series	28-29
Profi-Series.....	30-31
small quadro-Series	32-33

COLD WATER - POWERFUL

medium quadro-Series	36-37
large quadro-Series	38-39
Primus-Series	40-41
 Primus-RP-Series	42-43
 WS-RP-Series WSC-RP-Series	44-47
 LX-RP-Series	48-49

HIGH-PRESSURE CLEANERS WITH COMBUSTION ENGINE

Profi-Jet-Series	52-55
B-Series	56-57

HOT WATER HIGH-PRESSURE CLEANERS

HOT WATER - OIL HEATED

 therm-RP-Series	60-63
 therm-RP-Series - black edition	64-65
therm-1-Series	66-67
therm 1017-Series	68-69
therm-C-Series	70-71
therm-CA-Series	72-73

HIGH-PRESSURE CLEANERS - ELECTRICALLY HEATED

 e-therm-Series	76-77
--	-------

ACCESSORIES FOR HIGH-PRESSURE CLEANERS

 Accessories for plug-in system D12 - Complete	78-99
---	-------

HIGH-PRESSURE CLEANERS FOR PRIVATE USERS

Quickly-Series	102-103
K 1050-Series	104-105
Accessories for plug-in system D10	108

INDUSTRIAL VACUUM CLEANERS

Ventos-Series	112-113
 Accessories industrial vacuum cleaner	114-115

HAND POWER SWEEPERS

Colly 800	118-119
Kränzle 1+1	120-121



KRÄNZLE PRESENTS

NEW PRODUCTS

page 102-103



QUICKLY

The new Quickly cold water pressure washer is designed specifically for home use and delivers impressive results in terms of cleaning power and quality. With a working pressure of 130 bar, even the most stubborn dirt around the house and garden will be a thing of the past in no time. The intuitive D10 plug-in system and the included Round Cleaner UFO surface cleaner complete the package.

page 40-41



PRIMUS WITH AUTOMATIC HOSE REEL

High pressure, high cleaning capacity, robust construction and a wide range of accessories. The Primus-Series cold water pressure washers are ideal for agricultural and industrial applications. With the Primus 1000 TS AT and Primus 1200 TS AT models make work even faster. The automatic hose reel automatically rewinds the high-pressure hose for ease of use and safe storage.

page 42-43



PRIMUS-RP-SERIES

The advantages of the Primus-Series combined with a powerful Kränzle in-line RP pump: The Primus-RP 900 TST model expands the application range and capabilities of the Primus models with an operating pressure of 180 bar at a water flow rate of 15 l/min. The more compact Primus-RP model is ideal for use on small and medium-sized farms.

WS-RP AND WSC-RP RANGE EXTENSION

The new WS-RP 780 TS and WS-RP 900 TS models extend the range of stationary pressure washers. The new cleaners have the same features, but with water capacities of 780 l/h and 900 l/h, the range of applications is extended to cover even more cleaning applications.

page 44-47



THERM-RP SERIES – BLACK EDITION

To mark Kränzle's 50th anniversary, two new models are added to the popular therm-RP-Series. The Black Edition is completely black. The features are convincing. The therm-RP-Series impresses with its enormous washing power and the use of hot water up to 80 °C in areas with particularly heavy soiling. Other features include a digital control panel and an internal automatic hose reel.

page 64-65



VENTOS 42 MODELS

Whether in trade, industry or on the sales floor. With the Ventos-Series you are perfectly equipped for all cleaning tasks: dry and wet vacuuming, automatic start when using power tools or manual or automatic filter cleaning. With the new models Ventos 42 L/PC and Ventos 42 L/AC, the container size has been increase for extended operation.

page 112-113



BETTER PERFECT THAN CHEAP!



OUR CORPORATE VALUES

■ QUALITY

"Our goal is to consistently meet or exceed clearly defined standards in all areas of the company in order to provide our customers with consistently high quality."

■ FLEXIBILITY

"We are not closed to the challenges of the market and our customers. This openness allows us to respond flexibly and early to new requirements and to meet them within the limits of our resources."

■ INNOVATION

"To stand still is to go backwards. Through our own research and development, we want to continuously offer users added value in terms of performance, safety, handling and cost-effectiveness."

■ ENVIRONMENTAL AWARENESS

"From production to product. Through modern production, well thought-out logistics and sophisticated, durable products, we contribute to a conscious approach to the environment."

INTRODUCING kränzle®

For more than 50 years, Kränzle has stood for quality "Made in Germany". To achieve this, we combine our expertise and have always manufactured our high-pressure cleaners at our Illertissen site. We rely exclusively on high-quality materials, sophisticated technology and years of know-how.

And our values have not changed in 50 years. We are proud to say that Kränzle has stood for the highest quality, flexibility, innovation and environmental responsibility since the company was founded.

Committed to these values, our entire team, from the engineers in research and development to our employees in production and our specialists in logistics, sales and service, work together every day to meet the diverse requirements of the cleaning industry worldwide with innovations of the highest quality.

Over the past 50 years, the commitment of each and every team member to make our corporate philosophy a reality has made Kränzle one of the world's quality leaders for cleaning machines.





Leonard Würfel

Josef Kränzle

Ludwig Kränzle

THREE GENERATIONS – ONE SUCCESSFUL TEAM

Kränzle has been family-owned for more than 50 years and will remain so in the future. While the managing partners Josef Kränzle and his son Ludwig Kränzle are still running the company today, the third generation is already being introduced to the company. This ensures the continuity of the family business and the continuation of the company philosophy in the second and third generation.

50 YEARS

OF SUSTAINABLE QUALITY



Kränzle can look back on a successful history that began long before the company was founded. It all began on the day in 1958 when company founder Josef Kränzle started his first job at the Wieland Werke in Vöhringen as a "Vesperholer" (He was responsible for lunch). After this probationary period, Kränzle began his apprenticeship as a lathe operator (today's cutting machine operator) and, after receiving his master's certificate, worked his way up to master craftsman before leaving the company in 1974.



During this time, as an apprentice, Josef Kränzle came into contact with the first steam cleaner, which was introduced into the company and subsequently improved by Oskar Ehrle. Josef Kränzle was responsible for the turned and milled parts, which allowed him to discover the secrets of the pump and combustion chamber functions at a very early stage and to develop his passion for this technology.

It is therefore not surprising that Josef Kränzle founded his first own company, Josef Kränzle Armaturenbau in Illertissen, on September 1, 1974, after leaving Wieland Werke. This was the beginning of a success story.

MILESTONES:

1974 Foundation of Josef Kränzle Armaturenbau e.K.



In 1974, Josef Kränzle founded Kränzle Armaturenbau e.K. in his own garage with the aim of manufacturing high-quality high-pressure cleaners for the cleaning market. The idea for this was born during his time at Wieland. Here he saw the first steam cleaner in action and was involved in the development of spray guns.

1978 New production facility at Rudolf-Diesel-Strasse in Illertissen



Due to the high quality accessory products such as spray guns and lances, the company quickly outgrew the garage and a new production facility was considered shortly after the company was founded. In 1978, the company moved to Rudolf-Diesel-Strasse in Illertissen. At this time, Kränzle was not yet producing under its own name, but was manufacturing for established companies in the industry.

1981 Production of the first own high-pressure pump



Kränzle is now known in the industry as a specialist for cold and hot water high pressure cleaners and offers a wide range of accessories.

In the same year, Kränzle manufactures its first own high-pressure pump. This was an important step towards the company's own high-pressure cleaner.

1984

Production of the first Kränzle mobile high-pressure cleaner and foundation of I. Kränzle GmbH



In 1984, the time had finally come. Kränzle produces the first mobile high-pressure cleaner and in the same year founds the sales company Ingrid Kränzle GmbH in Bielefeld. Two years later, the high-pressure cleaner was ready for series production. The first Kränzle high pressure cleaner is launched.

2001

Expansion with a new production and logistics site in Illertissen



After many successful years, numerous patents and new products such as the Kränzle therm hot water high-pressure cleaner, Kränzle expands and increases its capacities with the new production and logistics site in Siemensstraße in Illertissen.

2010

Change of name to Josef Kränzle GmbH & Co. KG and expansion of the management team



Kränzle Armaturenbau e.K. is renamed to Josef Kränzle GmbH & Co KG, as it is still known today. Ludwig Kränzle joins the management team and runs the company together with his father Josef Kränzle.

2013

New sites in Poland and Switzerland



In the course of internationalization and in order to be able to implement the brand strategy even more efficiently, Kränzle expands its locations. Kränzle opens its first international subsidiaries in Poland (Warsaw) and Switzerland (Bremgarten).

2017

Consolidation of production and sales at headquarters in Illertissen



In order to improve internal processes, efficiency and customer focus, the headquarters of Ingrid Kränzle GmbH will be relocated from Bielefeld to Illertissen in 2017. From now on, production and sales will be located at the same site.

2024

50th anniversary



The success story of Josef Kränzle GmbH & Co. KG now spans more than 50 years. During this time, the company has grown from its beginnings in a garage to become an international industry leader. Innovative ideas as well as wise investments and decisions have set the course for further successful years

QUALITY HAS A NAME - AND MANY FACES





THE RIGHT KRÄNZLE FOR EVERY APPLICATION

The requirements for high-pressure cleaners, industrial hoovers and manual sweepers vary greatly from one industry to another. This is why Kränzle has developed a product range which, due to its breadth and depth, meets all requirements with ease.

Quality "Made in Germany". This is the claim and commitment for each of our product lines - from portable high-pressure cleaners, mobile high-pressure cleaners, high-pressure cleaners in cold and hot water versions and to stationary units.



MADE IN GERMANY

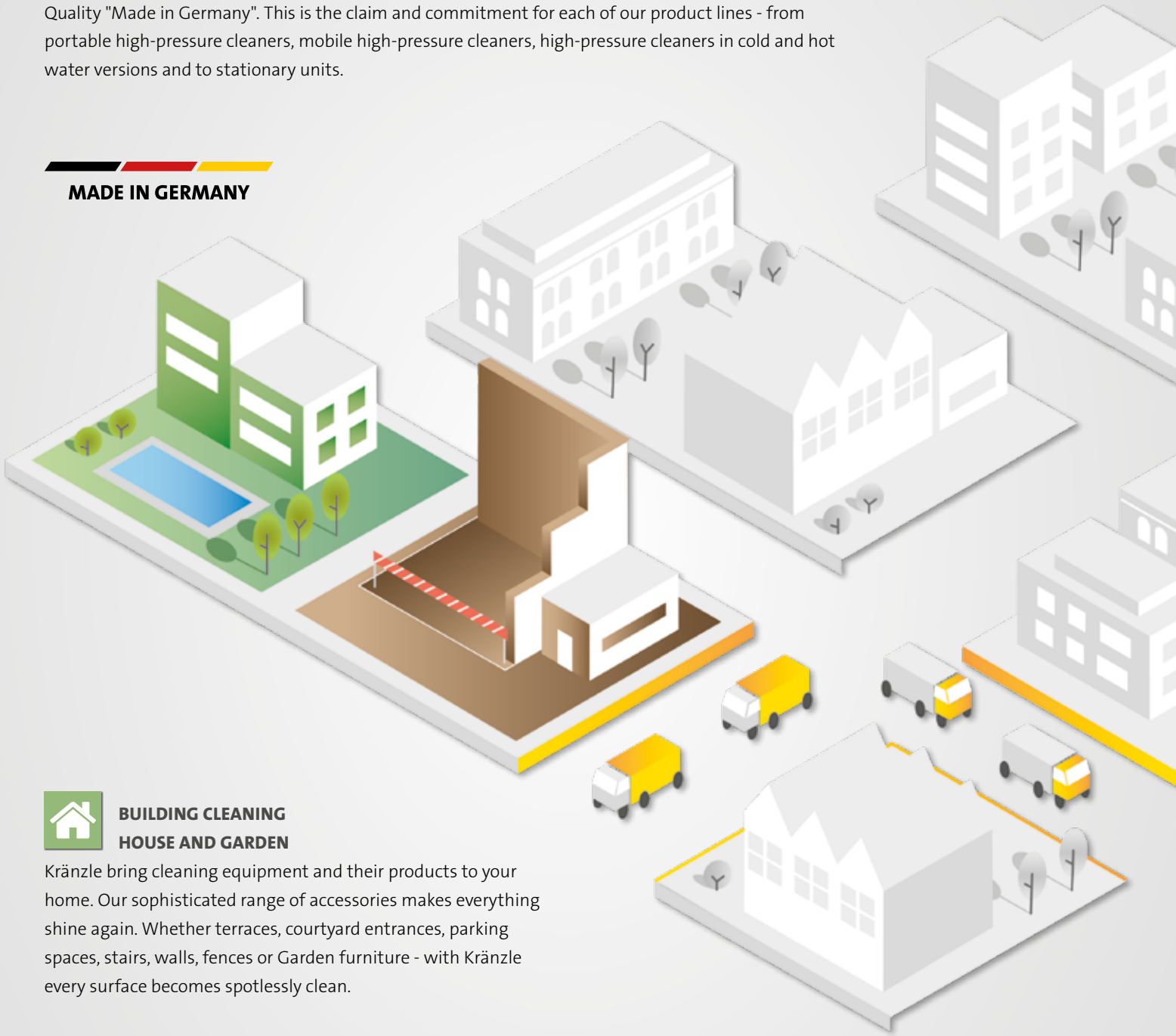

BUILDING CLEANING HOUSE AND GARDEN

Kränzle bring cleaning equipment and their products to your home. Our sophisticated range of accessories makes everything shine again. Whether terraces, courtyard entrances, parking spaces, stairs, walls, fences or Garden furniture - with Kränzle every surface becomes spotlessly clean.



CRAFT

Craftspeople work in difficult and challenging conditions. Kränzle works continuously to develop and improve its products to meet these challenges..



AUTOMOTIVE INDUSTRY HAULAGE FIRMS

Make your business shine! Whether your business is a car dealership, garage, valeting company, haulage or bus company, making a good first impression is important. Kränzle have an effective cleaning solution for whatever business requires.



AGRICULTURE LIVESTOCK FARMING

Cleanliness in agriculture and animal husbandry is a fundamental requirement for health, hygiene and good working conditions. Whether for the care of tractors and machines or for cleaning the stables and yards - a Kränzle high-pressure cleaner may be used.



PUBLIC SERVICE CONSTRUCTION

The cleaning operations in the public service require professional non compromising equipment. Kränzle High-pressure cleaners give the solution for the cleaning of construction vehicles, vans, public places or the Removal of graffiti on facades.

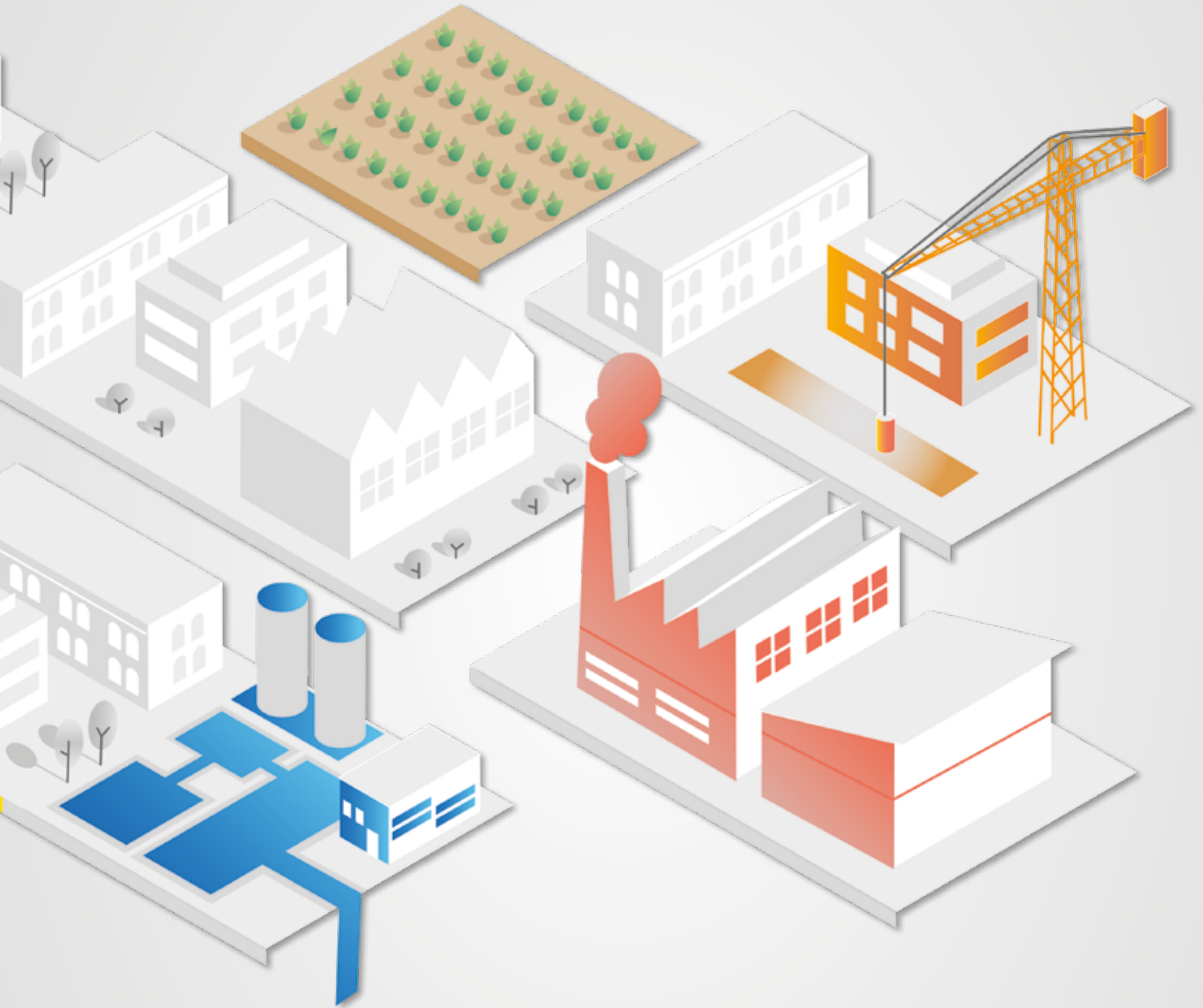

SANITARY FOOD

The Kränzle NoM versions (non-marking) are particularly suitable for use in hygiene and sanitary areas. White solid rubber tyres and grey high-pressure hoses leave no signs of abrasion, as required for these areas.



INDUSTRY

Premises and machines must be regularly inspected and dust, dirt and oil contamination removed. Kränzle offers high-quality cleaning machines with sophisticated accessories, which meet all the requirements of industrial companies.

WITH JUST A FEW CLICKS TO THE DESIRED PRODUCT

DIGITAL PRODUCT ADVISOR

Which high-pressure cleaner is best suited to the task at hand is often not obvious at first glance. Kränzle's newly developed digital product advisor helps to determine one's own requirements such as intended use, frequency of use or desired cleaning power. A few details and you quickly and easily receive a product recommendation tailored to your individual needs.



WITH JUST A FEW CLICKS

Intuitive and self-explanatory menu navigation saves time during the search.

AND QUESTIONS

Intended use, performance requirements and frequency of use determine product selection.

TO THE PERFECT RESULT

The right device and all the important technical data



**FIND YOUR DESIRED
PRODUCT NOW**

Scan QR code

ADVANTAGES PRODUCT ADVISOR

- can also be used on smartphone and tablet
- no app download necessary
- smart and free product recommendation
- individual needs analysis
- technical data and product information included



READY FOR

TOP PERFORMANCE

AT ANY TIME

HIGH-PRESSURE CLEANERS - PROFESSIONAL

QUALITY IN EVERY DETAIL

YOU CAN RELY ON KRÄNZLE

When you choose the Kränzle brand, you always get well-engineered high-pressure cleaners that convince all along the line. At our production site in Illertissen, southern Germany, every high-pressure cleaner is checked by hand before it leaves the factory. In this way, we guarantee users the highest quality, superior cleaning power and a particularly long service life.

THE KRÄNZLE PRODUCT ADVANTAGES

- high-quality materials and workmanship
- innovative design
- user-friendly handling
- environmentally conscious consumption
- extreme durability

MADE IN GERMANY

QUALITY "MADE IN GERMANY"

For us, quality already begins with product development, which is located at the Illertissen site. The production and quality control of almost all components also take place there.



QUICK RELEASE PLUG-IN SYSTEM | ANTI-TWIST PROTECTION

Sophisticated, fast and reliable: the quick release plug-in system with hardened stainless steel components ensures simple and always safe connection of the safety shut-off gun with the lance. Accessories that are equipped with an anti-twist protection can be locked in six various positions.



HEXAGONAL ANTI-ROTATION LOCK

Cleaning lances and accessories equipped with a hexagonal coupling can be locked against rotation in six different positions. This prevents the accessories from twisting unintentionally and allows them to be guided by moving the gun.



PRESSURE REGULATION | STAINLESS STEEL PRESSURE GAUGE

With all high-pressure cleaners (except the K 1050-Series), the working pressure and water quantity can be individually adjusted to the respective application. The large stainless steel pressure gauge provides a clear reading of the set working pressure. It contains a glycerine liquid that dampens possible fluctuations of the pointer.



SLOW RUNNING ELECTRIC MOTOR

Economical, quiet and durable: The particularly powerful high-pressure cleaners for continuous operation are equipped with a 4-pole electric motor. Its low speed of 1400 rpm reduces the starting current, thus ensuring less wear and noise.



TOTALSTOP SYSTEM | SAFETY SHUTDOWN

Energy consumption is reduced, service life increased: when closing off the high pressure gun, the motor switches off automatically, relieves the high-pressure pump and drive and reduces the noise level. If the high-pressure cleaner is accidentally not switched off, after 20 minutes it automatically goes into the safety shutdown by deactivating it.



HOSE REEL | TWIST-STOP SCREW CONNECTION

Models with hose reel allow for neat storage of the high-pressure hose. Prevents the high-pressure hose from twisting and tangling. Making operation much more user friendly.



ROTO-MOULD CHASSIS

The practically indestructible plastic housing gives the pressure washer additional stability. Motor and pump are well protected in the frame, securely shielded from external influences. The robust chassis ensures easy transport and high stability.



AXIAL PUMP | IN-LINE RP PUMP

The heart of every Kränzle high-pressure cleaner is the solid pump head made of forged special brass. Both tried and tested axial pump, which has been installed for decades, and the in-line RP pump introduced in 2018 for higher flushing performance, guarantee a long service life due to low-wear components.



WATER TANK

Always on the safe side: A float regulates the water inflow and prevents damage to the pump due to a lack of water.



DIRECT SUCTION WATER INLET

No water connection - no problem: high-pressure cleaners with a motor output of 1400 rpm offer the possibility of sucking water from separate containers or ponds due to the suction power of the high-pressure pumps.

INDESTRUCTIBLE, MOBILE & FAST TO HAND

"Can't be done?" These cold water high-pressure cleaners convince with their versatility, long service life and practical mobility. Whether compact and portable (HD-Series), space-saving with two wheels (K 1152-Series, X-Series, K 2000-Series, Profi-Series) or universal with four wheels (small quadro-Series) - in professional and semi-professional use, they inspire the specialist and delight the do-it-yourselfer. Kränzle provides a reliable, high-quality tool for every application.



TABLE OF CONTENTS

HD-Series	20-23
K 1152-Series	24-25
X-Series	26-27
K 2000-Series	28-29
Profi-Series	30-31
small quadro-Series	32-33
 Accessories for plug-in system D12	78-99

KEY INDUSTRIES



TECHNICAL HIGHLIGHTS



QUICK RELEASE PLUG-IN SYSTEM

Sophisticated, fast and reliable: the quick release plug-in system with hardened stainless steel components ensures simple and always safe connection of the safety shut-off gun with the lance.



TWIST-STOP SCREW CONNECTION

Go along with everything: provided with all machines: A special screw connection prevents the Twisting of the high-pressure hose during work and ensures so for consistent cleaning results in every situation.



PRESSURE REGULATION

Working pressure and water flow can be fully adjusted to suit the in all all high-pressure cleaners (with the exception of the K 1050-Series and Quickly).



TOTALSTOP SYSTEM

Energy consumption is reduced, service life is increased: when closing off the high pressure gun, the motor switches off automatically, relieves the high-pressure pump and drive and reduces the noise level.



COMPACT DESIGN

The perfect combination of form and function: the unique housing design of the Kränzle devices facilitates transport, and saves space.



OFF-ROAD CAPABILITY AND STABILITY

Goes over rough and smooth: the robust chassis makes it easier to transport and ensures high stability during use. Small Obstacles can be avoided thanks to the large wheels without any problems.

HD-Series



STAINLESS STEEL CARRY HANDLE
portable and space-saving compact design

STAINLESS STEEL PRESSURE GAUGE
easy reading of the working pressure

ELECTRIC MOTOR - 1400 RPM, 4-POLE
slower motor RPMs last longer, run quieter and allow for better in-let suction capabilities (HD 7/122 TS)

TOTAL-STOP SYSTEM
automatic standby of the motor reduces noise and power consumption when not in use

HD 7/122 TS | 600030

► **ACCESSORIES** | page 78-99



EQUIPMENT

- Quick release plug-in system D12
- Kränzle axial pump
- Total-Stop system
- Stepless pressure regulation
- Direct suction: Suction height HD 7/122 TS: 1.5 m
- High-pressure hose with Twist-Stop screw connection



MODEL	HD 7/122 TS	HD 10/122 TS
Ord.no.	600030	600080

TECHNICAL SPECIFICATIONS

Operating pressure	bar MPa	30-120 3-12	30-120 3-12
Water output	l/min l/h	7 420	10 600
Admissible overpressure	bar MPa	135 13.5	135 13.5
Motor speed	Rpm	1400	2800
Connection	V ~ Hz A	230 1 50 7.5	230 1 50 11
Power intake Power output	kW	1.6 1.0	2.5 1.8
Power supply cable	m	5	5
Dimensions L x W x H	mm	440 200 330	440 200 330
Weight	kg	23	23

EQUIPMENT

High-pressure hose	m Ord.no.	10 (DN6) 43416	10 (DN6) 43416
Trigger gun with safety catch	Model Ord.no.	Starlet 4 12525	Starlet 4 12525
Lance with flat jet nozzle	Nozzle Ord.no.	● 028 12435-M20028	● 042 12435-M20042
Lance with Dirtkiller	Nozzle Ord.no.	● 028 12438-028	● 042 12438-042



HD-Series



HD 9/80 TS | 600130

► **ACCESSORIES** | page 78-99



EQUIPMENT

- Quick release plug-in system D12
- Kränzle axial pump
- Total-Stop system
- Stepless pressure regulation
- Direct suction: Suction height HD 9/80 TS: 1.5 m | HD 12/130 TS: 2.5 m
- High-pressure hose with Twist-Stop screw connection



MODEL	HD 9/80 TS	HD 12/130 TS
Ord.no.	600130	600180

TECHNICAL SPECIFICATIONS

Operating pressure	bar MPa	30-80 3-8	30-130 3-13
Water output	l/min l/h	9 540	11 660
Admissible overpressure	bar MPa	90 9	145 14.5
Motor speed	Rpm	1400	1400
Connection	V ~ Hz A	230 1 50 7.5	230 1 50 13.5
Power intake Power output	kW	1.6 1.0	2.9 2.2
Power supply cable	m	5	5
Dimensions L x W x H	mm	470 230 320	500 240 320
Weight	kg	24	31

EQUIPMENT

High-pressure hose	m Ord.no.	10 (DN6) 43416	10 (DN6) 43416
Trigger gun with safety catch	Model Ord.no.	Starlet 4 12525	Starlet 4 12525
Lance with flat jet nozzle	Nozzle Ord.no.	● 042 12435-M20042	● 042 12435-M20042
Lance with Dirtkiller	Nozzle Ord.no.	● 042 12438-042	● 042 12438-042



K 1152-Series



ROTO-MOULD CHASSIS
practically indestructible
plastic housing

CONVENIENT INTEGRATED HOSE REEL (TST)
space-saving storage of the high-pressure
hose with twist stop screw connection

STAINLESS STEEL PRESSURE GAUGE
easy reading of the working pressure

ACCESSORY STORAGE
neat storage for high pressure
gun and lances

**OFF-ROAD CAPABILITY
AND STABILITY**
robust chassis for easy transport
and high stability

K 1152 TST | 602020

► **ACCESSORIES** | page 78-99



EQUIPMENT

-  Quick release plug-in system D12
- Kränzle axial pump
- Total-Stop system
- Stepless pressure regulation
- High-pressure hose with Twist-Stop screw connection



VARIANT - NON-MARKING

NOM conversion kit Version without drum	Ord.no.	42250
NOM conversion kit Version with drum	Ord.no.	42251

For further information on NON-Marking please refer to page 79

MODEL	K 1152 TS K 1152 TST
Ord.no. TS without hose drum	602010
Ord.no. TST incl. hose drum	602020

TECHNICAL SPECIFICATIONS

Operating pressure	bar MPa	30-130 3-13
Water output	l/min l/h	10 600
Admissible overpressure	bar MPa	150 15
Motor speed	Rpm	2800
Connection	V ~ Hz A	230 1 50 12
Power intake Power output	kW	2.8 2.0
Power supply cable	m	5
Dimensions L x W x H	mm	360 365 870
Weight without incl. hose drum	kg	28 30

EQUIPMENT

High-pressure hose TS without hose drum	m Ord.no.	10 (DN6) 43416
High-pressure hose TST incl. hose drum	m Ord.no.	15 (DN6) 48015
Trigger gun with safety catch	Model Ord.no.	Starlet 4 12525
Lance with Vario-Jet Duo	Nozzle Ord.no.	● 042 12433-042
Lance with Dirtkiller	Nozzle Ord.no.	● 042 12438-042



X-Series



ACCESSORY BOX

Integrated holder for practical storage of Kränzle foam lance and other accessories

CONVENIENT INTEGRATED HOSE REEL (TST)

space-saving storage of the high-pressure hose with twist stop screw connection

STAINLESS STEEL PRESSURE GAUGE

easy reading of the working pressure

OFF-ROAD CAPABILITY AND STABILITY

robust chassis for easy transport and high stability

ACCESSORY STORAGE

neat storage for high pressure gun and lances

ELECTRIC MOTOR - 1400 RPM, 4-POLE

slower motor RPMs last longer, run quieter and allow for better in-let suction capabilities (X 8/150 TST)

X 8/150 TST | 603600

► **ACCESSORIES** | page 78-99



EQUIPMENT

-  Quick release plug-in system D12
- Kränzle axial pump
- Total-Stop system
- Stepless pressure regulation
- High-pressure hose with Twist-Stop screw connection



MODEL	X 8/150 TST	X 10/140 TST
Ord.no. TST incl. hose drum	603600	603610

TECHNICAL SPECIFICATIONS

Operating pressure	bar MPa	30-150 3-15	30-140 3-14
Water output	l/min l/h	8 480	10 600
Admissible overpressure	bar MPa	170 17	160 16
Motor speed	Rpm	1400	2800
Connection	V ~ Hz A	230 1 50 9.8	230 1 50 12.8
Power intake Power output	kW	2.25 1.7	2.95 2.2
Power supply cable	m	5	5
Dimensions L x W x H	mm	470 360 875	470 360 875
Weight	kg	33	33

EQUIPMENT

High-pressure hose	m Ord.no.	15 (DN6) 498000	15 (DN6) 498000
Trigger gun with safety catch	Model Ord.no.	Starlet 4 12525	Starlet 4 12525
Lance with flat jet nozzle	Nozzle Ord.no.	○ 03 12435-M2003	● 042 12435-M20042
Lance with Dirtkiller	Nozzle Ord.no.	○ 03 12438-03	● 042 12438-042



K 2000-Series



CONVENIENT INTEGRATED HOSE REEL (TST)
space-saving storage of the high-pressure hose with twist stop screw connection

ROTO-MOULD CHASSIS
practically indestructible plastic housing

STAINLESS STEEL PRESSURE GAUGE
easy reading of the working pressure

ACCESSORY STORAGE
neat storage for high pressure gun and lances

OFF-ROAD CAPABILITY AND STABILITY
robust chassis for easy transport and high stability

K 2160 TST | 604020

► **ACCESSORIES** | page 78-99

EQUIPMENT

- Quick release plug-in system D12
- Kränzle axial pump
- Total-Stop system
- Stepless pressure regulation
- Direct suction: Suction height 2.5 m
- High-pressure hose with Twist-Stop screw connection





VARIANT - NON-MARKING

NOM conversion kit Version without drum	Ord.no.	42250
NOM conversion kit Version with drum	Ord.no.	42251
K 2160 TST NOM ex works	Ord.no.	604030

For further information on NON-Marking please refer to page 79

MODEL	K 2160 TS K 2160 TST	K 2195 TS K 2195 TST	K 2175 TS K 2175 TST
Ord.no. TS without hose drum	604010	604050	604110
Ord.no. TST incl. hose drum	604020	604060	604120

TECHNICAL SPECIFICATIONS

Operating pressure	bar MPa	30-140 3-14	30-170 3-17	30-160 3-16
Water output	l/min l/h	11 660	8 480	12 720
Admissible overpressure	bar MPa	160 16	195 19.5	175 17.5
Motor speed	Rpm	1400	1400	1400
Connection	V ~ Hz A	230 1 50 14	230 1 50 14	400 3 50 6.7
Power intake Power output	kW	3.2 2.4	3.2 2.4	3.3 2.6
Power supply cable	m	5	5	5
Dimensions L x W x H	mm	375 360 900	375 360 900	375 360 900
Weight without incl. hose drum	kg	39 40	39 40	39 40

EQUIPMENT

High-pressure hose TS without hose drum	m Ord.no.	10 (DN6) 43416	10 (DN6) 43416	10 (DN6) 43416
High-pressure hose TST incl. hose drum	m Ord.no.	15 (DN6) 48015	15 (DN6) 48015	15 (DN6) 48015
Trigger gun with safety catch	Model Ord.no.	Starlet 4 12525	Starlet 4 12525	Starlet 4 12525
Lance with Vario-Jet Duo	Nozzle Ord.no.	● 042 12433-042	○ 03 12433-03	● 042 12433-042
Lance with Dirtkiller	Nozzle Ord.no.	● 042 12438-042	○ 03 12438-03	● 042 12438-042



Profi-Series



ROTO-MOULD CHASSIS

practically indestructible plastic housing

CONVENIENT INTEGRATED HOSE REEL (TST)

space-saving storage of the high-pressure hose with twist stop screw connection

ELECTRIC MOTOR - 1400 RPM, 4-POLE

slower motor RPMs last longer, run quieter and allow for better in-let suction capabilities

STAINLESS STEEL PRESSURE GAUGE

easy reading of the working pressure

ACCESSORY STORAGE

neat storage for high pressure gun and lances

OFF-ROAD CAPABILITY AND STABILITY

robust chassis for easy transport and high stability



Profi 160 TST | 606000

► **ACCESSORIES** | page 78-99



EQUIPMENT

 Quick release plug-in system D12

■ Kränzle axial pump

■ Total-Stop system

■ Stepless pressure regulation

■ Optional: Internal Water Tank can be supplied upon request

■ Direct suction: Suction height 2.5 m

■ High-pressure hose with Twist-Stop screw connection



VARIANT - NON-MARKING

NOM conversion kit	Ord.no.	42260
---------------------------	---------	--------------

For further information on NON-Marking please refer to page 79

MODEL	Profi 160 TST	Profi 195 TST	Profi 175 TST
Ord.no. TST incl. hose drum	606000	606010	606100

TECHNICAL SPECIFICATIONS

Operating pressure	bar MPa	30-140 3-14	30-170 3-17	30-150 3-15
Water output	l/min l/h	11 660	8 480	12 720
Admissible overpressure	bar MPa	160 16	195 19.5	175 17.5
Motor speed	Rpm	1400	1400	1400
Connection	V ~ Hz A	230 1 50 14.3	230 1 50 14.3	400 3 50 7.2
Power intake Power output	kW	3.2 2.5	3.2 2.5	3.8 3.0
Power supply cable	m	5	5	5
Dimensions L x W x H	mm	355 375 980	355 375 980	355 375 980
Weight	kg	45	45	45

EQUIPMENT

High-pressure hose	m Ord.no.	15 (DN6) 43829	15 (DN6) 43829	15 (DN6) 43829
Trigger gun with safety catch	Model Ord.no.	Starlet 4 12525	Starlet 4 12525	Starlet 4 12525
Lance with flat-jet nozzle	Nozzle Ord.no.	● 042 12435-M20042	○ 03 12435-M2003	● 042 12435-M20042
Lance with Dirtkiller	Nozzle Ord.no.	● 042 12438-042	○ 03 12438-03	● 042 12438-042



Water tank

EXPERT TIP

Prevents damage to the high-pressure pump in case of water shortage

- Volume 1.3 liters
- Simple, tool-free assembly

Ord.no.	43860
----------------	--------------

small quadro-Series



CONVENIENT INTEGRATED HOSE REEL
space-saving storage of the high-pressure hose with twist stop screw connection

ACCESSORY STORAGE
neat storage for high pressure gun and lances

STAINLESS STEEL PRESSURE GAUGE
easy reading of the working pressure

WATER TANK
helps prevent damage to the device in case of water shortage

IMPACT PROTECTION
reduces accidental damage to the high-pressure pump

ROTO-MOULD CHASSIS
practically indestructible plastic housing

quadro 11/140 TST | 608000

► **ACCESSORIES** | page 78-99



EQUIPMENT

- Quick release plug-in system D12
- Kränzle axial pump
- Total-Stop system
- Stepless pressure regulation

- High-pressure hose with Twist-Stop screw connection
- Cleaning Agent Intake
- Locking brake
- Water tank: Volume 5 liters



VARIANT - NON-MARKING

42252

NOM conversion kit	Ord.no.	42252
quadro 11/140 TST NOM ex works	Ord.no.	608010

For further information on NON-Marking please refer to page 79

MODEL	quadro 11/140 TST	quadro 9/170 TST
Ord.no. TST incl. hose drum	608000	608020

TECHNICAL SPECIFICATIONS

Operating pressure	bar MPa	30-140 3-14	30-170 3-17
Water output	l/min l/h	11 660	9 540
Admissible overpressure	bar MPa	155 15.5	190 19
Motor speed	Rpm	1400	1400
Connection	V ~ Hz A	230 1 50 14	230 1 50 14
Power intake Power output	kW	3.3 2.4	3.3 2.4
Power supply cable	m	5	5
Dimensions L x W x H	mm	590 360 850	590 360 850
Weight	kg	47	47

EQUIPMENT

High-pressure hose	m Ord.no.	15 (DN6) 40170	15 (DN6) 40170
Trigger gun with safety catch	Model Ord.no.	Starlet 4 12525	Starlet 4 12525
Lance with flat-jet nozzle	Nozzle Ord.no.	● 045 12435-M20045	○ 03 12435-M2003
Lance with Dirtkiller	Nozzle Ord.no.	● 045 12438-045	○ 03 12438-03



COLD WATER HIGH-PRESSURE CLEANERS - ESPECIALLY POWERFUL DEVICES

SOVEREIGN HIGH-PERFORMANCE MACHINES WITH INNOVATIVE TECHNOLOGY



They take on any challenge: In agriculture or animal husbandry, on the construction site or in industry: with up to 250 bar working pressure, these professional machines get to work powerfully everywhere, even in continuous use. In daily use, they quickly prove to be indispensable tools.

RP High-pressure cleaners with in-line RP pump:

To achieve perfect cleanliness, a particularly high flushing effect is often required. The Kränzle high-pressure cleaners with innovative in-line RP pump achieve a water output of up to 1600 l/h and meet even the highest demands efficiently and effortlessly. Even the most stubborn dirt is removed in no time at all.

TABLE OF CONTENTS

medium quadro-Series	36-37
large quadro-Series	38-39
Primus-Series	40-41
RP Primus-RP-Series	42-43
RP WS-RP-Series WSC-RP-Series	44-47
RP LX-RP-Series	48-49
RP Accessories for plug-in system D12	78-99

KEY INDUSTRIES



TECHNICAL HIGHLIGHTS



QUICK RELEASE PLUG-IN SYSTEM

Sophisticated, fast and reliable: the quick release plug-in system with hardened stainless steel components ensures simple and always safe connection of the safety shut-off gun with the lance.



OFF-ROAD CAPABILITY AND STABILITY

Goes over rough and smooth: the robust chassis makes it easier to transport and ensures high stability during use. Small obstacles can be avoided thanks to the large wheels without any problems.



INTEGRATED HOSE REEL

Space-saving and convenient: with a folding crank handle for practical, neat storage of the high-pressure hose. A special locking device holds the reel in the desired position.



WATER TANK

Always on the safe side: A float regulates the water inflow and prevents damage to the pump due to a lack of water.



INNOVATIVE IN-LINE RP PUMP

Proven technology convincingly enhanced: a Crankshaft moves the plungers in line via connecting rods the in-line pump. This special design enables even greater water flow with significantly higher washing effect than conventional pumps and ensures impressive properties:

- Power transmission as with a car engine via stable crankshaft, connecting rod and plunger
- extremely long service life
- integrated unloader valve
- Total-stop system with delayed engine shutdown

medium quadro-Series



CONVENIENT INTEGRATED HOSE REEL (TST)
space-saving storage of the high-pressure hose
with twist stop screw connection

ACCESSORY STORAGE
neat storage for high pressure
gun and lances

STAINLESS STEEL PRESSURE GAUGE
easy reading of the working pressure

IMPACT PROTECTION
reduces accidental damage
to the high-pressure pump

WATER TANK
helps prevent damage to the
device in case of water shortage

ROTO-MOULD CHASSIS
practically indestructible
plastic housing

quadro 899 TST | 610120

► **ACCESSORIES** | page 78-99

EQUIPMENT

- Quick release plug-in system D12
- Kränzle axial pump
- Total-stop system with delayed motor cut-off
- Safety shutdown
- Stepless pressure regulation

- High-pressure hose with Twist-Stop screw connection
- Cleaning Agent Intake
- Locking brake
- Water tank: Volume 10 liters





VARIANT - NON-MARKING

NOM conversion kit	Ord.no.	42272
NOM conversion kit quadro 899 TST	Ord.no.	42271
quadro 799 TST NOM ex works	Ord.no.	61010

For further information on NON-Marking please refer to page 79

MODEL	quadro 599 TST	quadro 799 TST	quadro 899 TST
Ord.no. TST incl. hose drum	610000	610100	610120

TECHNICAL SPECIFICATIONS

Operating pressure	bar MPa	30-150 3-15	30-180 3-18	30-150 3-15
Water output	l/min l/h	10 600	13 780	15 900
Admissible overpressure	bar MPa	165 16.5	200 20	170 17
Motor speed	Rpm	1400	1400	1400
Connection	V ~ Hz A	230 1 50 14	400 3 50 8.5	400 3 50 8.5
Power intake Power output	kW	3.3 2.4	5.5 4.0	5.5 4.0
Power supply cable	m	5	7.5	7.5
Dimensions L x W x H	mm	780 395 870	780 395 870	780 395 870
Weight	kg	63	63	63

EQUIPMENT

High-pressure hose	m Ord.no.	20 (DN6) 434161	20 (DN6) 434161	15 (DN8) 44879
Trigger gun with safety catch	Model Ord.no.	Starlet 3 12500	Starlet 3 12500	Starlet 3 12500
Lance with flat-jet nozzle	Nozzle Ord.no.	● 035 12420-D25035	● 045 12420-D25045	● 06 12420-D2506
Lance with Dirtkiller	Nozzle Ord.no.	● 035 12425-035	● 045 12425-045	● 06 12425-06



large quadro-Series



CONVENIENT INTEGRATED HOSE REEL (TST)
space-saving storage of the high-pressure hose
with twist stop screw connection

ACCESSORY STORAGE
neat storage for high pressure
gun and lances

STAINLESS STEEL PRESSURE GAUGE
easy reading of the working pressure

WATER TANK
helps prevent damage to the
device in case of water shortage

STAINLESS STEEL CHASSIS
durable and corrosion
resistant

IMPACT PROTECTION
reduces accidental damage to
the high-pressure pump

quadro 1200 TST | 612120

► **ACCESSORIES** | page 78-99



EQUIPMENT

Quick release plug-in system D12

- Kränzle axial pump
- Total-stop system with delayed motor cut-off
- Safety shutdown
- Stepless pressure regulation

- High-pressure hose with Twist-Stop screw connection
- Cleaning Agent Intake
- Stainless steel undercarriage
- Locking brake
- Water tank: Volume 12 liters



VARIANT - NON-MARKING

42280

NOM conversion kit Version without drum	Ord.no.	42280
NOM conversion kit Version with drum	Ord.no.	42282
quadro 1200 TST NOM ex works	Ord.no.	612130

For further information on NON-Marking please refer to page 79

MODEL	quadro 800 TST	quadro 1000 TS quadro 1000 TST	quadro 1200 TS quadro 1200 TST
Ord.no. TS without hose drum	–	612080	612110
Ord.no. TST incl. hose drum	612060	612090	612120

TECHNICAL SPECIFICATIONS

Operating pressure	bar MPa	30-250 3-25	30-220 3-22	30-180 3-18
Water output	l/min l/h	13.3 800	16 960	19 1140
Admissible overpressure	bar MPa	270 27	250 25	200 20
Motor speed	Rpm	1400	1400	1400
Connection	V ~ Hz A	400 3 50 12	400 3 50 12	400 3 50 12
Power intake Power output	kW	7.5 5.5	7.5 5.5	7.5 5.5
Power supply cable	m	7.5	7.5	7.5
Dimensions L x W x H	mm	770 570 990	770 570 990	770 570 990
Weight without incl. hose drum	kg	– 89	83 89	83 89

EQUIPMENT

High-pressure hose TS without hose drum	m Ord.no.	–	10 (DN8) 41081	10 (DN8) 41081
High-pressure hose TST incl. hose drum	m Ord.no.	20 (DN8) 41083	20 (DN8) 41083	20 (DN8) 41083
Trigger gun with safety catch	Model Ord.no.	Starlet 3 12500	Starlet 3 12500	Starlet 3 12500
Lance with flat-jet nozzle	Nozzle Ord.no.	● 04 12420-D2504	● 05 12420-D2505	● 07 12420-D2507
Lance with Turbokiller (**for TST series only)	Nozzle Ord.no.	● 04 12430-04 **	● 05 12430-05 **	● 07 12430-07 **



Primus-Series



ACCESSORY STORAGE

neat storage for high pressure gun and lances

CONVENIENT INTEGRATED HOSE REEL (TST)

space-saving storage of the high-pressure hose with twist stop screw connection

ROLL-ON AND ROLL-OFF AID

Enables effortless rolling up and unrolling of the high-pressure hose

STAINLESS STEEL PRESSURE GAUGE

easy reading of the working pressure

ROTO-MOULD CHASSIS

practically indestructible plastic housing

IMPACT PROTECTION

reduces accidental damage to the high-pressure pump

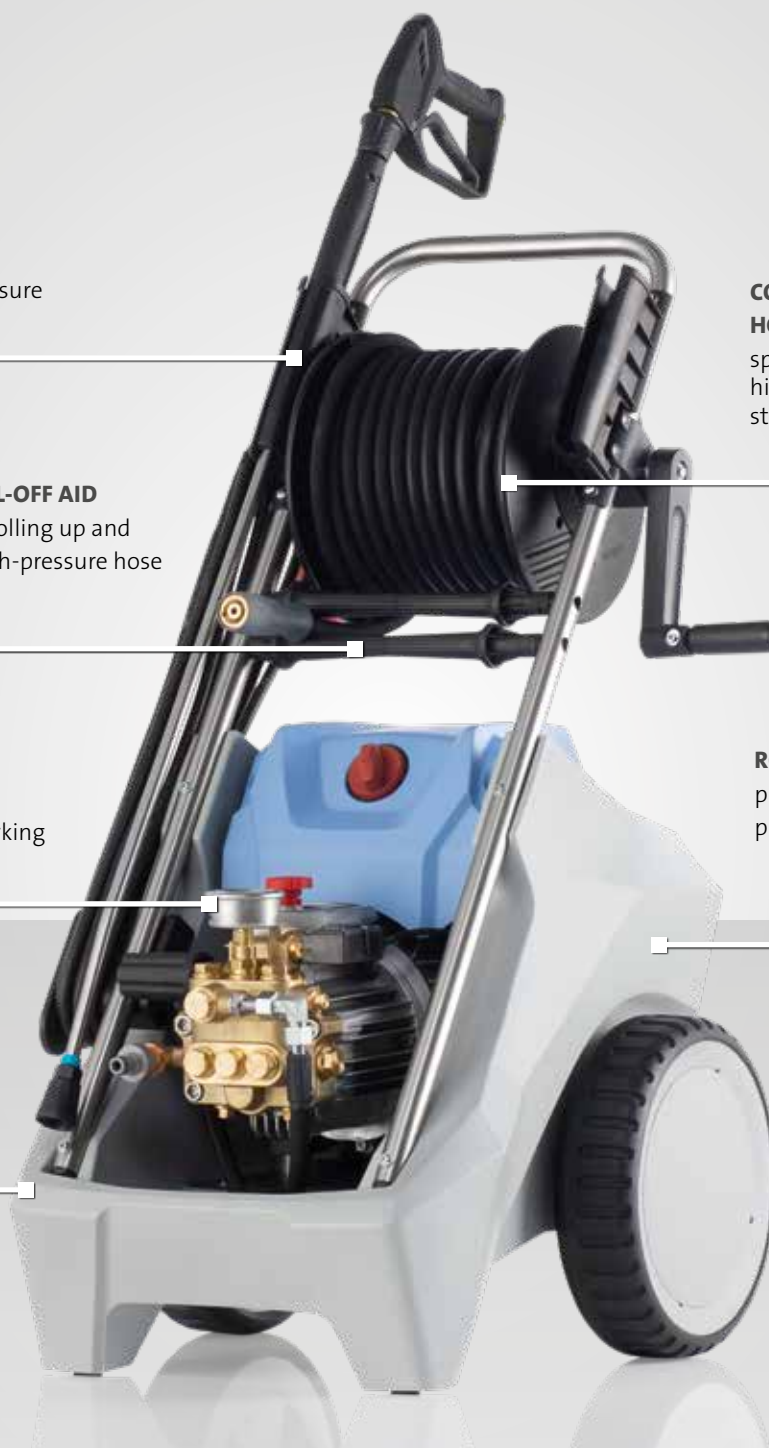

Primus 1000 TST | 614150

► **ACCESSORIES** | page 78-99

EQUIPMENT

- Quick release plug-in system D12
- Kränzle axial pump
- Total-stop system with delayed motor cut-off
- Safety shutdown
- Stepless pressure regulation
- High-pressure hose with Twist-Stop screw connection





AUTOMATIC HOSE REEL

automatic hose retraction with
Twist-Stop screw connection
(Primus 1000 TS AT + Primus 1200 TS AT)

MODEL	Primus 1000 TST	Primus 1000 TS AT	Primus 1200 TST	Primus 1200 TS AT
Ord.no. TST incl. hose drum	614150	–	614160	–
Ord.no. TST incl. automatic hose reel	–	614155 NEW	–	614165 NEW

TECHNICAL SPECIFICATIONS

Operating pressure	bar MPa	30-220 3-22	30-220 3-22	30-180 3-18	30-180 3-18
Water output	l/min l/h	16.6 1000	16.6 1000	20 1200	20 1200
Admissible overpressure	bar MPa	250 25	250 25	200 20	200 20
Motor speed	Rpm	1400	1400	1400	1400
Connection	V ~ Hz A	400 3 50 11.4	400 3 50 11.4	400 3 50 11.4	400 3 50 11.4
Power intake Power output	kW	7.5 5.5	7.5 5.5	7.5 5.5	7.5 5.5
Power supply cable	m	7.5	7.5	7.5	7.5
Dimensions L x W x H	mm	640 515 985	640 515 1100	640 515 985	640 515 1100
Weight	kg	75	88	75	88

EQUIPMENT

High-pressure hose	m Ord.no.	20 (DN8) 443812	20 (DN8) 410832	20 (DN8) 443812	20 (DN8) 410832
Trigger gun with safety catch	Model Ord.no.	Starlet 3 12500	Starlet 3 12500	Starlet 3 12500	Starlet 3 12500
Lance with flat-jet nozzle	Nozzle Ord.no.	● 05 12420-D2505	● 05 12420-D2505	● 07 12420-D2507	● 07 12420-D2507



Primus-RP-Series



NEW

ACCESSORY STORAGE

neat storage for high pressure gun and lances

CONVENIENT INTEGRATED HOSE REEL (TST)

space-saving storage of the high-pressure hose with twist stop screw connection

ROLL-ON AND ROLL-OFF AID

Enables effortless rolling up and unrolling of the high-pressure hose

STAINLESS STEEL PRESSURE GAUGE

easy reading of the working pressure

ROTO-MOULD CHASSIS

practically indestructible plastic housing

IMPACT PROTECTION



reduces accidental damage to the high-pressure pump



Primus-RP 900 TST | 614140

► **ACCESSORIES** | page 78-99

EQUIPMENT

-  Quick release plug-in system D12
-  Kränzle in-line RP pump
 - Total-stop system with delayed motor cut-off
 - Safety shutdown
 - Stepless pressure regulation
 - High-pressure hose with Twist-Stop screw connection





MODEL	Primus-RP 900 TST	NEU
Ord.no. TST incl. hose drum	614140 *	

TECHNICAL SPECIFICATIONS

Operating pressure	bar MPa	30-180 3-18
Water output	l/min l/h	15 900
Admissible overpressure	bar MPa	200 20
Motor speed	Rpm	1400
Connection	V ~ Hz A	400 3 50 9.4
Power intake Power output	kW	5.5 4.0
Power supply cable	m	7.5
Plug		CEE 16 A
Dimensions L x W x H	mm	600 465 995
Weight	kg	59

EQUIPMENT

High-pressure hose	m Ord.no.	20 (DN8) 443812
Trigger gun with safety catch	Model Ord.no.	Starlet 3 12500
Lance with flat-jet nozzle	Nozzle Ord.no.	● 055 12420-D25055



WS-RP-Series | WSC-RP-Series

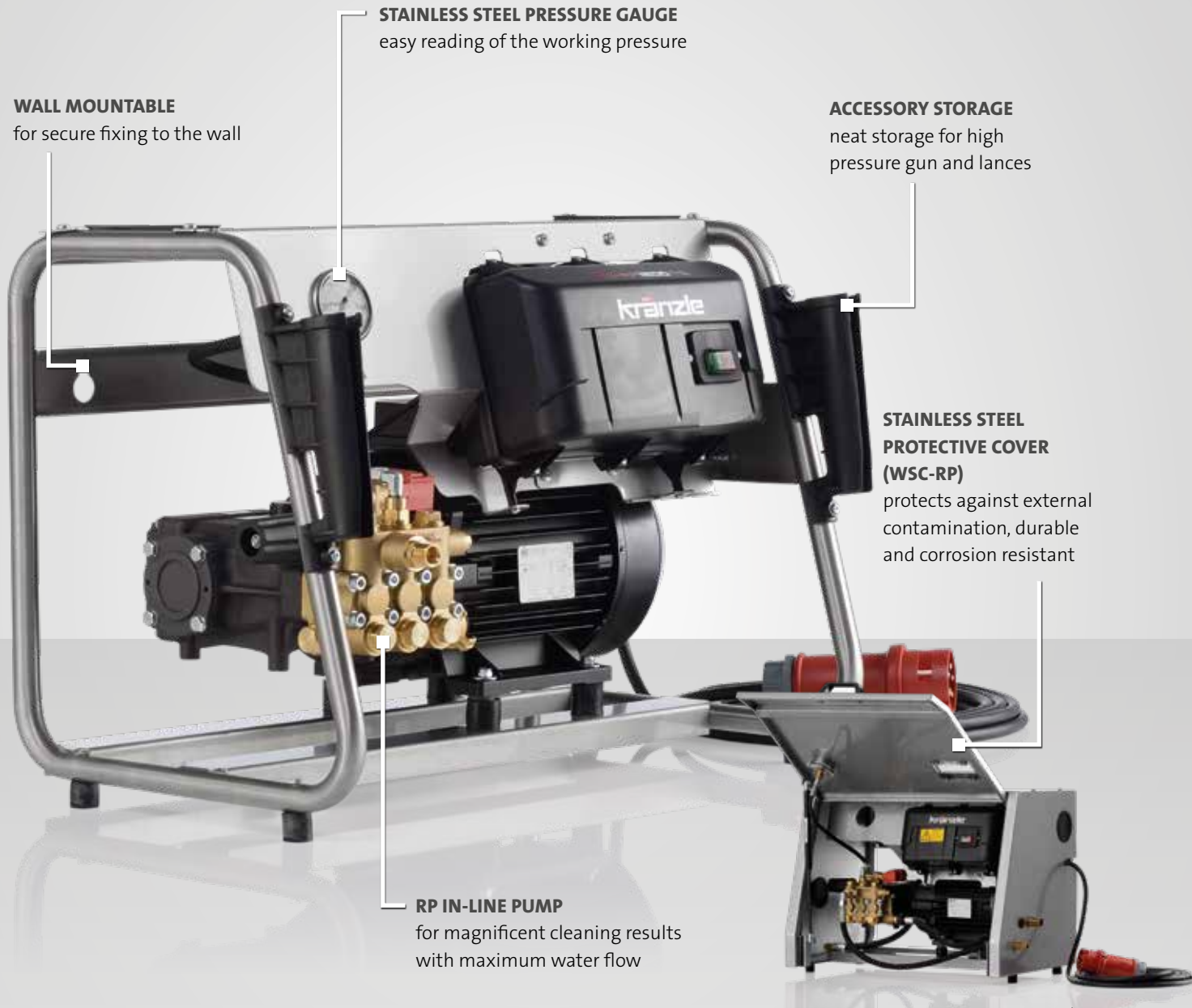

STAINLESS STEEL PRESSURE GAUGE
easy reading of the working pressure

ACCESSORY STORAGE
neat storage for high pressure gun and lances

STAINLESS STEEL PROTECTIVE COVER (WSC-RP)
protects against external contamination, durable and corrosion resistant

RP IN-LINE PUMP
for magnificent cleaning results with maximum water flow

WALL MOUNTABLE
for secure fixing to the wall

WS-RP 1200 TS | 622120
WSC-RP 1200 TS | 622130

► **ACCESSORIES** | page 78-99



EQUIPMENT

- Quick release plug-in system D12
- Kränzle in-line RP pump
 - Standing device and wall unit
 - Total-stop system with delayed motor cut-off
- Safety shutdown
- Stepless pressure regulation
- Stainless-steel housing (WSC-RP)
- High-pressure hose with Twist-Stop screw connection



Conversion kit - flow monitor

For leakage protection in the pipe network.
Suitable for non-monitored areas.

Ord.no.	126342	
Flow rate	l/min	4

MODEL	WS-RP 1000 TS WSC-RP 1000 TS	WS-RP 1200 TS WSC-RP 1200 TS	WS-RP 1400 TS WSC-RP 1400 TS	WS-RP 1600 TS WSC-RP 1600 TS
Ord.no. WS without cover	622100	622120	622140	622160
Ord.no. WSC with cover	622110	622130	622150	622170

TECHNICAL SPECIFICATIONS

Operating pressure	bar MPa	30-200 3-20	30-190 3-19	30-170 3-17	30-150 3-15
Water output	l/min l/h	16.6 1000	20 1200	23.3 1400	26.7 1600
Admissible overpressure	bar MPa	220 22	210 21	200 20	170 17
Motor speed	Rpm	1400	1400	1400	1400
Connection	V ~ Hz A	400 3 50 13.5	400 3 50 14.3	400 3 50 14.3	400 3 50 14.3
Power intake Power output	kW	7.5 6.0	8.0 6.3	8.0 6.3	8.0 6.3
Power supply cable	m	7.5	7.5	7.5	7.5
Plug		CEE 32 A	CEE 32 A	CEE 32 A	CEE 32 A
Dimensions L x W x H	mm	670 430 510	670 430 510	670 430 510	670 430 510
Weight without with cover	kg	62 65	62 65	62 65	62 65

EQUIPMENT

High-pressure hose	m Ord.no.	10 (DN8) 41081	10 (DN8) 41081	10 (DN8) 41081	10 (DN8) 41081
Trigger gun with safety catch	Model Ord.no.	Starlet 3 12500	Starlet 3 12500	Starlet 3 12500	Starlet 3 12500
Lance with flat-jet nozzle	Nozzle Ord.no.	● 05 12420-D2505	● 065 12420-D25065	● 08 12420-D2508	● 11 12420-D2511



Wall holder-WS/WSC

EXPERT TIP

Ord.no.	483006
----------------	---------------

WS-RP-Series | WSC-RP-Series



NEW





WS-RP 780 TS | 622060
WSC-RP 780 TS | 622070

► **ACCESSORIES** | page 78-99



EQUIPMENT

 Quick release plug-in system D12

 Kränzle in-line RP pump

■ Standing device and wall unit

■ Total-stop system with delayed motor cut-off

■ Safety shutdown

■ Stepless pressure regulation

■ Stainless-steel housing (WSC-RP)

■ High-pressure hose with Twist-Stop screw connection



Conversion kit - flow monitor

For leakage protection in the pipe network.
Suitable for non-monitored areas.

Ord.no.		126342
Flow rate	l/min	4

MODEL	WS-RP 780 TS WSC-RP 780 TS	NEW	WS-RP 900 TS WSC-RP 900 TS	NEW
Ord.no. WS without cover	622060 *		622080 *	
Ord.no. WSC with cover	622070 *		622090 *	

TECHNICAL SPECIFICATIONS

Operating pressure	bar MPa	30-150 3-15	30-180 3-18
Water output	l/min l/h	13 780	15 900
Admissible overpressure	bar MPa	170 17	200 20
Motor speed	Rpm	1400	1400
Connection	V ~ Hz A	400 3 50 8.0	400 3 50 9.4
Power intake Power output	kW	5.5 4.0	5.5 4.0
Power supply cable	m	7.5	7.5
Plug		CEE 16 A	CEE 16 A
Dimensions L x W x H	mm	670 430 510	670 430 510
Weight without with cover	kg	52 55	52 55

EQUIPMENT

High-pressure hose	m Ord.no.	10 (DN8) 41081	10 (DN8) 41081
Trigger gun with safety catch	Model Ord.no.	Starlet 3 12500	Starlet 3 12500
Lance with flat-jet nozzle	Nozzle Ord.no.	● 05 12420-D2505	● 05 12420-D2505



Wall holder-WS/WSC

EXPERT TIP

Ord.no.	483006
----------------	---------------

LX-RP-Series



CONVENIENT INTEGRATED HOSE REEL

space-saving storage of the high-pressure hose with twist stop screw connection

ACCESSORY STORAGE

neat storage for high pressure gun and lances

STAINLESS STEEL PROTECTIVE COVER

durable and corrosion resistant

STAINLESS STEEL PRESSURE GAUGE

easy reading of the working pressure

IMPACT PROTECTION

reduces accidental damage to the high-pressure pump

RP IN-LINE PUMP

for magnificent cleaning results with maximum water flow





LX-RP 1600 TST | 616080

► **ACCESSORIES** | page 78-99



EQUIPMENT

 Quick release plug-in system D12

 Kränzle in-line RP pump

■ Total-stop system with delayed motor cut-off

■ Safety shutdown

■ Stepless pressure regulation

■ High-pressure hose with Twist-Stop screw connection

■ Locking brake

■ Direct suction: Suction height 2.5 m



VARIANT - NON-MARKING

NOM conversion kit Ord.no. **42283**

For further information on NON-Marking please refer to page 79

MODEL	LX-RP 1000 TST	LX-RP 1200 TST	LX-RP 1400 TST	LX-RP 1600 TST
Ord.no. TST incl. hose drum	616050	616060	616070	616080

TECHNICAL SPECIFICATIONS

Operating pressure	bar MPa	30-200 3-20	30-190 3-19	30-170 3-17	30-150 3-15
Water output	l/min l/h	16.6 1000	20 1200	23.3 1400	26.7 1600
Admissible overpressure	bar MPa	220 22	210 21	190 19	170 17
Motor speed	Rpm	1400	1400	1400	1400
Connection	V ~ Hz A	400 3 50 13.5	400 3 50 14.3	400 3 50 14.3	400 3 50 14.3
Power intake Power output	kW	7.5 6.0	8.0 6.3	8.0 6.3	8.0 6.3
Power supply cable	m	7.5	7.5	7.5	7.5
Plug		CEE 32 A	CEE 32 A	CEE 32 A	CEE 32 A
Dimensions L x W x H	mm	735 580 1020	735 580 1020	735 580 1020	735 580 1020
Weight	kg	94	94	94	94

EQUIPMENT

High-pressure hose	m Ord.no.	20 (DN8) 443812	20 (DN8) 443812	20 (DN8) 443812	20 (DN8) 443812
Trigger gun with safety catch	Model Ord.no.	Starlet 3 12500	Starlet 3 12500	Starlet 3 12500	Starlet 3 12500
Lance with flat-jet nozzle	Nozzle Ord.no.	● 05 12420-D2505	● 065 12420-D40065	● 08 12420-D4008	● 11 12420-D4011





HIGH-PRESSURE CLEANERS WITH INTERNAL COMBUSTION ENGINE

EXCEPTIONAL CLEANING RESULTS, ANYWHERE, EVERY TIME

For these machines nowhere is too far: Kränzle high-pressure cleaners with petrol engines allow an almost unlimited radius of action. The reliable and maintenance-friendly Machines are reliable in every situation. Even a water connection is not absolutely necessary. Thanks to the suction hose the appliance can take water from pools, lakes or rivers, with a prefilter to protect against contamination. Highest cleaning power for convincing results are thus available everywhere.

TABLE OF CONTENTS

Profi-Jet-Series	52-55
B-Series	56-57
 Accessories for plug-in system D12	78-99

KEY INDUSTRIES





TECHNICAL HIGHLIGHTS



PROVEN ENGINES

Service-friendly and economical: the reliable Honda Motors with low oil protection. Fuel consumption and noise development can be reduced via the optional speed regulation.



OPERATION WITHOUT POWER/WATER CONNECTION

No electricity - no problem: petrol-powered engines are devices independent of the power supply, the Suction hose with suction filter for water basins or lakes do not require a mains water connection.

Profi-Jet-Series



CARRY HANDLE

portable and space-saving compact design

STAINLESS STEEL PROTECTIVE COVER

protects against external contamination, durable and corrosion resistant



HONDA PETROL ENGINE

reliable, service-friendly, L-type reduction version for optimum pairing, and with low oil protection

STAINLESS STEEL PRESSURE GAUGE

easy reading of the working pressure

Profi-Jet B 13/150 | 618001

► **ACCESSORIES** | page 78-99



EQUIPMENT

- Quick release plug-in system D12
- Kränzle axial pump
- Combustion engine Honda
- Stepless pressure regulation
- High-pressure hose with Twist-Stop screw connection
- Direct suction: Suction height 2.5 m



MODEL	Profi-Jet B 13/150	Profi-Jet B 10/200
Ord.no.	618001	618021

TECHNICAL SPECIFICATIONS

Operating pressure	bar MPa	30-150 3-15	30-200 3-20
Water output	l/min l/h	13 780	10 600
Admissible overpressure	bar MPa	170 17	220 22
Engine		Honda GX160 LX	Honda GX200 LX
Dimensions L x W x H	mm	520 360 420	520 360 420
Weight	kg	35	35

EQUIPMENT

High-pressure hose	m Ord.no.	10 (DN8) 44878	10 (DN8) 41081
Trigger gun with safety catch	Model Ord.no.	Starlet 4 12525	Starlet 4 12525
Lance with regulating nozzle	Nozzle Ord.no.	● 05 12439-D2505	○ 03 12439-D2503
Lance with Dirtkiller	Nozzle Ord.no.	● 05 12438-05	○ 03 12438-03
Water inlet filter	Ord.no.	13310	13310



Profi-Jet-Series



STAINLESS STEEL CHASSIS
durable and corrosion resistant

CONVENIENT INTEGRATED HOSE REEL (VARIANT)
space-saving storage of the high-pressure hose with twist stop screw connection

ACCESSORY STORAGE
neat storage for high pressure gun and lances

STAINLESS STEEL PRESSURE GAUGE
easy reading of the working pressure

HONDA PETROL ENGINE
reliable, service-friendly, L-type reduction version for optimum pairing, and with low oil protection

AUTOMATIC SPEED REGULATION
reduces fuel consumption and noise levels (from model Profi-Jet B 16/220)

Profi-Jet B 16/220 T | 618049

► **ACCESSORIES** | page 78-99



EQUIPMENT

- Quick release plug-in system D12
- Kränzle axial pump
- Combustion engine Honda
- Stepless pressure regulation
- High-pressure hose with Twist-Stop screw connection
- Direct suction: Suction height 2.5 m



MODEL	Profi-Jet B 13/150	Profi-Jet B 10/200	Profi-Jet B 16/220	Profi-Jet B 20/200	Profi-Jet B 16/250
Ord.no. without hose drum	618003	618023	618045	618065	618085
Ord.no. incl. hose drum	618007	618027	618049	618069	618089

TECHNICAL SPECIFICATIONS

Operating pressure	bar MPa	30-150 3-15	30-200 3-20	30-220 3-22	30-200 3-20	30-250 3-25
Water output	l/min l/h	13 780	10 600	16 960	20 1200	16 960
Admissible overpressure	bar MPa	170 17	220 22	240 24	220 22	270 27
Engine		Honda GX160 LX	Honda GX200 LX	Honda GX340 LX	Honda GX390 LX	Honda GX390 LX
Speed adjustment		–	–	●	●	●
Dimensions L x W x H without hose drum	mm	770 570 990	770 570 990	770 570 990	770 570 990	770 570 990
Dimensions L x W x H incl. hose drum	mm	770 570 1005	770 570 1005	785 570 1005	785 570 1005	785 570 1005
Weight without incl. hose drum	kg	42 50	42 50	65 73	65 73	65 73

EQUIPMENT

High-pressure hose without hose drum	m Ord.no.	10 (DN8) 44878	10 (DN8) 41081	10 (DN8) 41081	10 (DN8) 41081	10 (DN8) 41081
High-pressure hose incl. hose drum	m Ord.no.	20 (DN8) 41083	20 (DN8) 41083	20 (DN8) 41083	20 (DN8) 41083	20 (DN8) 41083
Trigger gun with safety catch	Model Ord.no.	Starlet 3 12500	Starlet 3 12500	Starlet 3 12500	Starlet 3 12500	Starlet 3 12500
Lance with regulating nozzle	Nozzle Ord.no.	● 05 12431-D2505	○ 03 12431-D2503	● 05 12431-D2505	● 07 12431-D2507	● 045 12431-D25045
Lance with Dirtkiller	Nozzle Ord.no.	● 05 12425-05	○ 03 12425-03	–	–	–
Lance with Turbokiller	Nozzle Ord.no.	–	–	● 05 12430-05	● 07 12430-07	● 045 12430-045
Water inlet filter	Ord.no.	13310	13310	13310	13310	13310



Suction hose with suction filter

EXPERT TIP

For sucking in water from external sources
 ■ Hose length 3 m

Ord.no.	150383
---------	--------

B-Series



CONVENIENT INTEGRATED HOSE REEL

space-saving storage of the high-pressure hose with twist stop screw connection

ACCESSORY STORAGE

neat storage for high pressure gun and lances

STAINLESS STEEL PRESSURE GAUGE

easy reading of the working pressure

HONDA PETROL ENGINE

reliable, service-friendly, L-type reduction version for optimum pairing, and with low oil protection

AUTOMATIC SPEED REGULATION

reduces fuel consumption and noise levels (from model B 230 T)

IMPACT PROTECTION

reduces accidental damage to the high-pressure pump



B 240 T | 620023

► **ACCESSORIES** | page 78-99



EQUIPMENT

 Quick release plug-in system D12

- Kränzle axial pump
- Combustion engine Honda
- Stepless pressure regulation
- High-pressure hose with Twist-Stop screw connection

- Locking brake
- Direct suction: Suction height 2.5 m



MODEL	B 170 T	B 230 T	B 240 T	B 270 T
Ord.no. incl. hose drum	620001	620013	620023	620033

TECHNICAL SPECIFICATIONS

Operating pressure	bar MPa	30-150 3-15	30-200 3-20	30-220 3-22	30-250 3-25
Water output	l/min l/h	12.5 750	20 1200	16 960	16 960
Admissible overpressure	bar MPa	170 17	230 23	240 24	270 27
Engine		Honda GX160 LX	Honda GX390 LX	Honda GX340 LX	Honda GX390 LX
Speed adjustment		–	●	●	●
Dimensions L x W x H	mm	720 570 960	720 570 960	720 570 960	720 570 960
Weight	kg	67	92	92	92

EQUIPMENT

High-pressure hose	m Ord.no.	20 (DN8) 41083	20 (DN8) 41083	20 (DN8) 41083	20 (DN8) 41083
Trigger gun with safety catch	Model Ord.no.	Starlet 3 12500	Starlet 3 12500	Starlet 3 12500	Starlet 3 12500
Lance with regulating nozzle	Nozzle Ord.no.	● 05 12431-D2505	● 07 12431-D2507	● 05 12431-D2505	● 045 12431-D25045
Lance with Dirtkiller	Nozzle Ord.no.	● 05 12425-05	–	–	–
Lance with Turbokiller	Nozzle Ord.no.	–	● 07 12430-07	● 05 12430-05	● 045 12430-045
Water inlet filter	Ord.no.	13310	13310	13310	13310



Suction hose with suction filter

EXPERT TIP

For sucking in water from external sources
 ■ Hose length 3 m

Ord.no.	150383
---------	--------

MAXIMUM CLEANING EFFICIENCY WITH HOT WATER



Dirt, bacteria and viruses make a big fuss: some contaminants, such as grease or oil, are difficult to remove. But it is easier with hot water. This is where Kränzle hot water high-pressure cleaners come into play. Their high water temperatures of up to 155 °C in the steam stage increase the cleaning power and also have a disinfecting effect.

RP High-pressure cleaner with in-line RP pump:

Our flagship for the very highest applications: The Kränzle therm-RP-Series with innovative in-line pump delivers hot water at high pressure and is particularly suitable for applications where an above-average flushing effect at high working pressure is required. With a water output of up to 1600 l/h, even the most stubborn dirt does not stand a chance.

TABLE OF CONTENTS

RP therm-RP-Series	60-63
RP therm-RP-Series - black edition	64-65
therm-1-Series	66-67
therm 1017-Series	68-69
therm-C-Series	70-71
therm-CA-Series	72-73
RP Accessories for plug-in system D12	78-99

KEY INDUSTRIES



TECHNICAL HIGHLIGHTS



TWIST-STOP SCREW CONNECTION

Go along with everything: provided with all machines: A special screw connection prevents the Twisting of the high-pressure hose during work and ensures so for consistent cleaning results in every situation.



DIGITAL CONTROL PANEL

With the digital temperature control, the water temperature and the heat output can be measured exactly and can be controlled via two operating modes. This gives the ability to work precisely even with partial water quantities and low temperatures.



SAFETY DEVICES

Protection at every aspect: features such as a safety valve, flow monitor, optical flame monitoring, overcurrent release, pressure switch and low fuel cut-off switch ensure for absolute safe operation.



OPTICAL FLAME MONITORING AND THERMAL OVERLOAD PROTECTION

Electronic monitoring of combustion: Kränzle therm devices have a photocell to monitor the burner flame. This ensures safe operation at all times, even if the user is not near. Additionally, an overheating protection sensor measures the temperature at the exhaust; switching off heating automatically if more than 260 °C is detected.

(Exception: entry-level model therm-CA)



TOTAL-STOP SYSTEM WITH DELAYED MOTOR SHUTDOWN

Energy consumption is reduced, longer life: when closing the high pressure gun the motor switches off automatically, relieves the high-pressure pump and drive and reduces noise. Thanks to a small time-delay when switching off machines means that with very short work breaks the full working pressure is immediately restored.

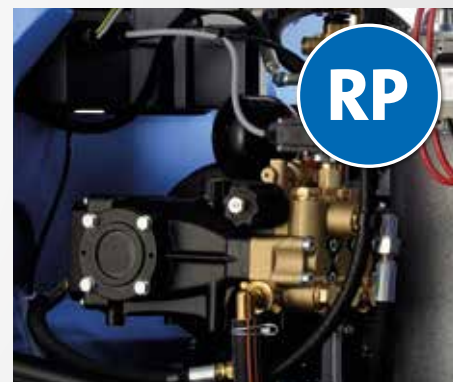

INNOVATIVE IN-LINE RP PUMP

Proven technology convincingly enhanced: a Crankshaft moves the plungers in line via connecting rods the in-line pump. This special design enables even greater water flow with significantly higher washing effect than conventional pumps and ensures impressive properties:

- Power transmission as with a car engine
- extremely long service life
- integrated unloader valve
- Total-stop system

therm-RP-Series



ACCESSORY STORAGE
neat storage for high pressure gun and lances

CONVENIENT INTEGRATED HOSE REEL (VARIANT)
space-saving storage of the high-pressure hose with twist stop screw connection

REMOVABLE COVERS
convenient and easy service access

DIGITAL CONTROL PANEL
digital temperature regulation with 2 different operation modes

VISUAL FLAME MONITORING AND OVERHEATING PROTECTION
(on page 59)

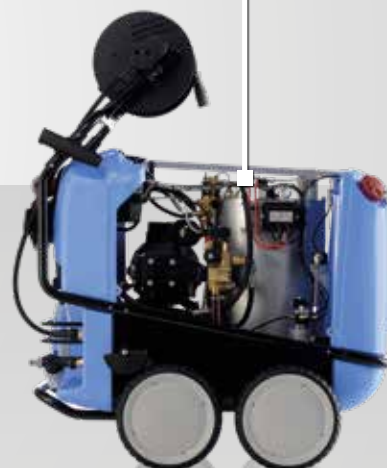

therm-RP 1000 | 638210

► **ACCESSORIES** | page 78-99



EQUIPMENT

- Quick release plug-in system D12
- Kränzle in-line RP pump
 - Total-stop system with delayed motor cut-off
 - Safety shutdown
 - Pressure regulation
 - Cleaning Agent Intake
 - Locking brake
 - Water tank: Volume 12 liters
 - Optional: Stainless steel heating coil

EQUIPMENT HOT WATER

- Digital thermostat
- Flow monitor
- Combustion chamber pre-ventilation
- Visual flame monitoring
- Overheating protection (exhaust temperature in excess of 260 °C)
- Burner stops when there is a lack of heating oil
- Operating hours meter
- Fuel tank: 35 liters



VARIANT - NON-MARKING

42280

NOM conversion kit Version without drum	Ord.no.	42280
NOM conversion kit Version with drum	Ord.no.	42281

For further information on NON-Marking please refer to page 79

MODEL	therm-RP 1000 therm-RP 1000 T	therm-RP 1200 therm-RP 1200 T	therm-RP 1400 therm-RP 1400 T	therm-RP 1600 therm-RP 1600 T
Ord.no. without hose drum	638200	638400	638600	638800
Ord.no. incl. hose drum	638210	638410	638610	638810
Ord.no. without hose drum ▶ with stainless steel heating coil	638250	638450	638650	638850
Ord.no. incl. hose drum ▶ with stainless steel heating coil	638260	638460	638660	638860

TECHNICAL SPECIFICATIONS

Operating pressure	bar MPa	70-200 7-20	70-190 7-19	70-170 7-17	70-150 7-15
Water output	l/min l/h	16.6 1000	20 1200	23.3 1400	26.7 1600
Admissible overpressure	bar MPa	220 22	210 21	190 19	170 17
Motor speed	Rpm	1400	1400	1400	1400
Connection	V ~ Hz A	400 3 50 13.5	400 3 50 14.3	400 3 50 14.3	400 3 50 14.3
Power intake Power output	kW	7.5 6.0	8.0 6.3	8.0 6.3	8.0 6.3
Power supply cable	m	7.5	7.5	7.5	7.5
Plug		CEE 32 A	CEE 32 A	CEE 32 A	CEE 32 A
Dimensions L x W x H without hose drum	mm	1050 800 1015	1050 800 1015	1050 800 1015	1050 800 1015
Dimensions L x W x H incl. hose drum	mm	1050 800 1300	1050 800 1300	1050 800 1300	1050 800 1300
Weight without incl. hose drum	kg	210 218	210 218	210 218	210 218

TECHNICAL DATA HOT WATER

Hot water output	°C	12-80	12-80	12-80	12-80
Steam level	°C	140	140	140	140
Oil consumption at max. heating output	kg/h l/h	6.0 7.0	7.7 9.2	7.7 9.2	7.7 9.2
Heating oil consumption ΔT 45°	kg/h l/h	5.6 6.6	5.6 6.6	5.6 6.6	5.6 6.6
Heating output	kW	65	84	84	84

EQUIPMENT

High-pressure hose without hose drum	m Ord.no.	10 (DN8) 41081	10 (DN8) 41081	10 (DN8) 41081	10 (DN8) 41081
High-pressure hose incl. hose drum	m Ord.no.	20 (DN8) 443812	20 (DN8) 443812	20 (DN8) 443812	20 (DN8) 443812
Trigger gun with safety catch	Model Ord.no.	Starlet 3 12500	Starlet 3 12500	Starlet 3 12500	Starlet 3 12500
Lance with flat-jet nozzle	Nozzle Ord.no.	● 05 12420-D2505	● 065 12420-D25065	● 08 12420-D2508	● 11 12420-D2511
Water inlet filter	Ord.no.	13310	13310	13310	13310

therm-RP-Series



DIGITAL CONTROL PANEL

digital temperature regulation
with 2 different operation modes

ACCESSORY STORAGE

neat storage for high
pressure gun and lances

REMOVABLE COVERS

convenient and easy service access

AUTOMATIC HOSE REEL

automatic hose retraction with
Twist-Stop screw connection

**VISUAL FLAME MONITORING AND
OVERHEATING PROTECTION**

(on page 59)



therm-RP 1400 AT | 638620

► **ACCESSORIES** | page 78-99



EQUIPMENT

- Quick release plug-in system D12
- Kränzle in-line RP pump
 - Automatic hose reel
 - Total-stop system with delayed motor cut-off
 - Safety shutdown
 - Pressure regulation
 - Cleaning Agent Intake
 - Locking brake
 - Water tank: Volume 12 liters

EQUIPMENT HOT WATER

- Digital thermostat
- Flow monitor
- Combustion chamber pre-ventilation
- Visual flame monitoring
- Overheating protection (exhaust temperature in excess of 260 °C)
- Burner stops when there is a lack of heating oil
- Operating hours meter
- Fuel tank: 35 liters

AUTOMATIC HOSE REEL

By means of a return spring inside the drum the high pressure hose is automatically rolled up. Guide rollers enable flexible rolling up in all directions.



MODEL	therm-RP 1000 AT	therm-RP 1200 AT	therm-RP 1400 AT	therm-RP 1600 AT
Ord.no. AT incl. automatic hose reel	638220	638420	638620	638820

TECHNICAL SPECIFICATIONS

Operating pressure	bar MPa	70-200 7-20	70-190 7-19	70-170 7-17	70-150 7-15
Water output	l/min l/h	16.6 1000	20 1200	23.3 1400	26.7 1600
Admissible overpressure	bar MPa	220 22	210 21	190 19	170 17
Motor speed	Rpm	1400	1400	1400	1400
Connection	V ~ Hz A	400 3 50 13.5	400 3 50 14.3	400 3 50 14.3	400 3 50 14.3
Power intake Power output	kW	7.5 6.0	8.0 6.3	8.0 6.3	8.0 6.3
Power supply cable	m	7.5	7.5	7.5	7.5
Plug		CEE 32 A	CEE 32 A	CEE 32 A	CEE 32 A
Dimensions L x W x H	mm	1300 800 1015	1300 800 1015	1300 800 1015	1300 800 1015
Weight	kg	240	240	240	240

TECHNICAL DATA HOT WATER

Hot water output	°C	12-80	12-80	12-80	12-80
Steam level	°C	140	140	140	140
Oil consumption at max. heating output	kg/h l/h	6.0 7.0	7.7 9.2	7.7 9.2	7.7 9.2
Heating oil consumption ΔT 45°	kg/h l/h	5.6 6.6	5.6 6.6	5.6 6.6	5.6 6.6
Heating output	kW	65	84	84	84

EQUIPMENT

High-pressure hose	m Ord.no.	20 (DN8) 41083	20 (DN8) 41083	20 (DN8) 41083	20 (DN8) 41083
Trigger gun with safety catch	Model Ord.no.	Starlet 3 12500	Starlet 3 12500	Starlet 3 12500	Starlet 3 12500
Lance with flat-jet nozzle	Nozzle Ord.no.	● 05 12420-D2505	● 065 12420-D25065	● 08 12420-D2508	● 11 12420-D2511
Water inlet filter	Ord.no.	13310	13310	13310	13310

therm-RP-Series - black edition



NEW

ACCESSORY STORAGE
neat storage for high pressure gun and lances

REMOVABLE COVERS
convenient and easy service access

CONVENIENT INTEGRATED HOSE REEL (VARIANT)
space-saving storage of the high-pressure hose with twist stop screw connection

DIGITAL CONTROL PANEL
digital temperature regulation with 2 different operation modes

VISUAL FLAME MONITORING AND OVERHEATING PROTECTION
(on page 59)



therm-RP 900 T | 638110

► **ACCESSORIES** | page 78-99



EQUIPMENT

- Quick release plug-in system D12
- Kränzle in-line RP pump
 - Total-stop system with delayed motor cut-off
 - Safety shutdown
 - Pressure regulation
 - Cleaning Agent Intake
 - Locking brake
 - Water tank: Volume 12 liters

EQUIPMENT HOT WATER

- Digital thermostat
- Flow monitor
- Combustion chamber pre-ventilation
- Visual flame monitoring
- Overheating protection (exhaust temperature in excess of 260 °C)
- Burner stops when there is a lack of heating oil
- Operating hours meter
- Fuel tank: 35 liters

INTEGRATED AUTOMATIC HOSE REEL (VARIANT)

automatic hose retraction with Twist-Stop screw connection (therm-RP 900 AT)



MODEL	therm-RP 900 T therm-RP 900 AT	NEW
Ord.no. T incl. hose drum	638110 *	
Ord.no. AT incl. automatic hose reel	638120 **	

TECHNICAL SPECIFICATIONS

Operating pressure	bar MPa	70-170 7-17
Water output	l/min l/h	15 900
Admissible overpressure	bar MPa	190 19
Motor speed	Rpm	1400
Connection	V ~ Hz A	400 3 50 9.4
Power intake Power output	kW	5.5 4.0
Power supply cable	m	7.5
Plug		CEE 16 A
Dimensions L x W x H incl. hose drum	mm	1050 800 1300
Dimensions L x W x H incl. automatic hose reel	mm	1050 800 1015
Weight incl. hose drum incl. automatic hose reel	kg	205 210

TECHNICAL DATA HOT WATER

Hot water output	°C	12-85
Steam level	°C	155
Oil consumption at max. heating output	kg/h l/h	5.8 6.8
Heating oil consumption $\Delta T 45^\circ$	kg/h l/h	4.2 5.0
Heating output	kW	60

EQUIPMENT

High-pressure hose incl. hose drum	m Ord.no.	20 (DN8) 443812
High-pressure hose incl. automatic hose reel	m Ord.no.	15 (DN8) 44879
Trigger gun with safety catch	Model Ord.no.	Starlet 3 12500
Lance with flat-jet nozzle	Nozzle Ord.no.	● 055 12420-D25055
Water inlet filter	Ord.no.	13310

therm-1-Series



ACCESSORY STORAGE
neat storage for high pressure gun and lances

CONVENIENT INTEGRATED HOSE REEL (VARIANT)
space-saving storage of the high-pressure hose with twist stop screw connection

REMOVABLE COVERS
convenient and easy service access

DIGITAL CONTROL PANEL
digital temperature regulation with 2 different operation modes

VISUAL FLAME MONITORING AND OVERHEATING PROTECTION
(on page 59)

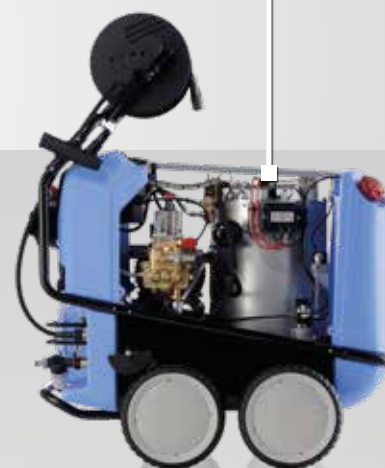

therm 895-1 | 634410

► **ACCESSORIES** | page 78-99



EQUIPMENT

- Quick release plug-in system D12
- Kränzle axial pump
- Total-stop system with delayed motor cut-off
- Safety shutdown
- Pressure regulation
- Cleaning Agent Intake
- Locking brake
- Direct suction (therm 895-1, therm 1165-1): Suction height 2.5 m
- Water tank: Volume 12 liters

EQUIPMENT HOT WATER

- Digital thermostat
- Flow monitor
- Combustion chamber pre-ventilation
- Visual flame monitoring
- Overheating protection (exhaust temperature in excess of 260 °C)
- Burner stops when there is a lack of heating oil
- Operating hours meter
- Fuel tank: 35 liters



VARIANT - NON-MARKING

NOM conversion kit Version without drum	Ord.no.	42280
NOM conversion kit Version with drum	Ord.no.	42281

For further information on NON-Marking please refer to page 79

MODEL	therm 635-1 therm 635-1 T	therm 875-1 therm 875-1 T	therm 895-1 therm 895-1 T	therm 1165-1 therm 1165-1 T
Ord.no. without hose drum	634000	634200	634400	634600
Ord.no. incl. hose drum	634010	634210	634410	634610

TECHNICAL SPECIFICATIONS

Operating pressure	bar MPa	30-130 3-13	30-175 3-17.5	30-195 3-19.5	30-165 3-16.5
Water output	l/min l/h	10.6 635	14.6 875	14.9 895	19.4 1165
Admissible overpressure	bar MPa	145 14.5	190 19	215 21.5	180 18
Motor speed	Rpm	1400	1400	1400	1400
Connection	V ~ Hz A	230 1 50 15	400 3 50 8.7	400 3 50 12	400 3 50 12
Power intake Power output	kW	3.4 2.3	4.8 4.0	6.4 5.0	6.4 5.0
Power supply cable	m	5	7.5	7.5	7.5
Dimensions L x W x H without hose drum	mm	1050 800 1015	1050 800 1015	1050 800 1015	1050 800 1015
Dimensions L x W x H incl. hose drum	mm	1050 800 1300	1050 800 1300	1050 800 1300	1050 800 1300
Weight without incl. hose drum	kg	197 205	197 205	214 222	214 222

TECHNICAL DATA HOT WATER

Hot water output	°C	12-89	12-87	12-86	12-82
Steam level	°C	145	155	155	155
Oil consumption at max. heating output	kg/h l/h	5.1 6.1	5.8 6.8	6.0 7.1	7.1 8.5
Heating oil consumption ΔT 45°	kg/h l/h	3.2 3.8	4.2 5.0	4.3 5.1	5.6 6.6
Heating output	kW	55	60	65	78

EQUIPMENT

High-pressure hose without hose drum	m Ord.no.	10 (DN8) 41081	10 (DN8) 41081	10 (DN8) 41081	10 (DN8) 41081
High-pressure hose incl. hose drum	m Ord.no.	20 (DN8) 443812	20 (DN8) 443812	20 (DN8) 443812	20 (DN8) 443812
Trigger gun with safety catch	Model Ord.no.	Starlet 3 12500	Starlet 3 12500	Starlet 3 12500	Starlet 3 12500
Lance with flat-jet nozzle	Nozzle Ord.no.	● 045 12420-D25045	● 045 12420-D25045	● 045 12420-D25045	● 07 12420-D2507
Water inlet filter	Ord.no.	13310	13310	13310	13310

therm 1017-Series



ACCESSORY STORAGE

neat storage for high pressure gun and lances

CONVENIENT INTEGRATED HOSE REEL (VARIANT)

space-saving storage of the high-pressure hose with twist stop screw connection

CONTROL PANEL

analogue temperature regulation

REMOVABLE COVERS

convenient and easy service access

VISUAL FLAME MONITORING AND OVERHEATING PROTECTION

(on page 59)



therm 1017 | 632210

► **ACCESSORIES** | page 78-99



EQUIPMENT

- Quick release plug-in system D12
- Kränzle axial pump
- Total-stop system with delayed motor cut-off
- Safety shutdown
- Pressure regulation
- Cleaning Agent Intake
- Locking brake
- Direct suction: Suction height 2.5 m
- Water tank: Volume 12 liters

EQUIPMENT HOT WATER

- Eco mode
- Flow monitor
- Combustion chamber pre-ventilation
- Visual flame monitoring
- Overheating protection (exhaust temperature in excess of 260 °C)
- Burner stops when there is a lack of heating oil
- Fuel tank: 35 liters



MODEL	therm 1017 therm 1017 T
Ord.no. without hose drum	632200
Ord.no. incl. hose drum	632210

TECHNICAL SPECIFICATIONS

Operating pressure	bar MPa	30-150 3-15
Water output	l/min l/h	16.7 1000
Admissible overpressure	bar MPa	170 17
Motor speed	Rpm	1400
Connection	V ~ Hz A	400 3 50 8.5
Power intake Power output	kW	5.5 4.0
Power supply cable	m	7.5
Dimensions L x W x H without hose drum	mm	1050 800 1015
Dimensions L x W x H incl. hose drum	mm	1050 800 1300
Weight without incl. hose drum	kg	193 198

TECHNICAL DATA HOT WATER

Hot water output	°C	12-80
Steam level	°C	140
Oil consumption at max. heating output	kg/h l/h	6.2 7.4 ▶ eco: 4.8 6.3
Heating oil consumption ΔT 45°	kg/h l/h	5.6 6.6
Heating output	kW	68

EQUIPMENT

High-pressure hose without hose drum	m Ord.no.	10 (DN8) 44878
High-pressure hose incl. hose drum	m Ord.no.	20 (DN8) 44877
Trigger gun with safety catch	Model Ord.no.	Starlet 3 12500
Lance with flat-jet nozzle	Nozzle Ord.no.	● 06 12420-D2506
Water inlet filter	Ord.no.	13310

therm-C-Series



CONTROL PANEL

analogue temperature regulation

CONVENIENT INTEGRATED HOSE REEL (VARIANT)

space-saving storage of the high-pressure hose with twist stop screw connection

ACCESSORY STORAGE

neat storage for high pressure gun and lances

REMOVABLE COVERS

convenient and easy service access

VISUAL FLAME MONITORING AND OVERHEATING PROTECTION

(on page 59)



therm-C 13/180 | 628210

► **ACCESSORIES** | page 78-99

EQUIPMENT

-  Quick release plug-in system D12
- Kränzle axial pump
- Total-stop system with delayed motor cut-off
- Safety shutdown
- Pressure regulation
- Cleaning Agent Intake
- Locking brake
- Water tank: Volume 3 liters



EQUIPMENT HOT WATER

- Flow monitor
- Combustion chamber pre-ventilation
- Visual flame monitoring
- Overheating protection (exhaust temperature in excess of 260 °C)
- Burner stops when there is a lack of heating oil
- Fuel tank: 25 liters



VARIANT - NON-MARKING

42271

NOM conversion kit Version without drum	Ord.no.	42270
NOM conversion kit Version with drum	Ord.no.	42271

For further information on NON-Marking please refer to page 79

MODEL	therm C 11/130 therm C 11/130 T	therm C 13/180 therm C 13/180 T	therm C 15/150 therm C 15/150 T
Ord.no. without hose drum	628000	628200	628350
Ord.no. incl. hose drum	628010	628210	628360

TECHNICAL SPECIFICATIONS

Operating pressure	bar MPa	30-130 3-13	30-180 3-18	30-150 3-15
Water output	l/min l/h	11 660	13 780	15 900
Admissible overpressure	bar MPa	145 14.5	200 20	170 17
Motor speed	Rpm	1400	1400	1400
Connection	V ~ Hz A	230 1 50 15	400 3 50 8.7	400 3 50 8.7
Power intake Power output	kW	3.4 2.3	4.8 4.0	4.8 4.0
Power supply cable	m	5	7.5	7.5
Dimensions L x W x H without hose drum	mm	860 580 970	860 580 970	860 580 970
Dimensions L x W x H incl. hose drum	mm	860 580 1220	860 580 1220	860 580 1220
Weight without incl. hose drum	kg	164 169	164 169	164 169

TECHNICAL DATA HOT WATER

Hot water output	°C	12-80	12-80	12-80
Steam level	°C	140	150	150
Oil consumption at max. heating output	kg/h l/h	5.1 6.1	5.8 6.8	6.0 7.1
Heating oil consumption $\Delta T 45^\circ$	kg/h l/h	3.2 3.8	3.8 4.5	4.3 5.1
Heating output	kW	55	60	65

EQUIPMENT

High-pressure hose without hose drum	m Ord.no.	10 (DN8) 44878	10 (DN8) 44878	10 (DN8) 44878
High-pressure hose incl. hose drum	m Ord.no.	15 (DN8) 44879	15 (DN8) 44879	15 (DN8) 44879
Trigger gun with safety catch	Model Ord.no.	Starlet 3 12500	Starlet 3 12500	Starlet 3 12500
Lance with flat-jet nozzle	Nozzle Ord.no.	● 045 12420-D25045	● 045 12420-D25045	● 055 12420-D25055
Water inlet filter	Ord.no.	13310	13310	13310

therm-CA-Series



ACCESSORY STORAGE
neat storage for high pressure gun and lances

CONVENIENT INTEGRATED HOSE REEL (VARIANT)
space-saving storage of the high-pressure hose with twist stop screw connection

REMOVABLE COVERS
convenient and easy service access

CONTROL PANEL
analogue temperature regulation

POWERFUL ENTRY MODEL
with all important basic functions

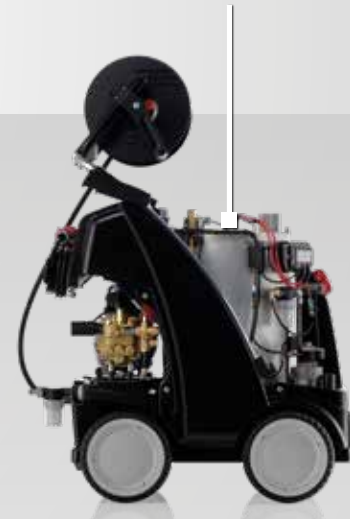

therm-CA 12/150 | 626210

► **ACCESSORIES** | page 78-99

EQUIPMENT

-  Quick release plug-in system D12
- Kränzle axial pump
- Total-Stop system
- Pressure regulation
- Cleaning Agent Intake
- Locking brake
- Water tank: Volume 3 liters



EQUIPMENT HOT WATER

- Flow monitor
- Combustion chamber pre-ventilation
- Fuel tank: 25 liters



MODEL	therm CA 11/130 therm CA 11/130 T	therm CA 12/150 therm CA 12/150 T
Ord.no. without hose drum	626000	626200
Ord.no. incl. hose drum	626010	626210

TECHNICAL SPECIFICATIONS

Operating pressure	bar MPa	30-130 3-13	30-150 3-15
Water output	l/min l/h	11 660	12 720
Admissible overpressure	bar MPa	145 14.5	165 16.5
Motor speed	Rpm	1400	1400
Connection	V ~ Hz A	230 1 50 15	400 3 50 7.2
Power intake Power output	kW	3.4 2.3	3.8 3.0
Power supply cable	m	5	7.5
Dimensions L x W x H without hose drum	mm	860 580 970	860 580 970
Dimensions L x W x H incl. hose drum	mm	860 580 1220	860 580 1220
Weight without incl. hose drum	kg	159 164	159 164

TECHNICAL DATA HOT WATER

Hot water output	°C	12-80	12-80
Steam level	°C	140	140
Oil consumption at max. heating output	kg/h l/h	5.1 6.1	5.4 6.4
Heating oil consumption $\Delta T 45^\circ$	kg/h l/h	3.2 3.8	3.5 4.1
Heating output	kW	55	58

EQUIPMENT

High-pressure hose without hose drum	m Ord.no.	10 (DN8) 44878	10 (DN8) 44878
High-pressure hose incl. hose drum	m Ord.no.	15 (DN8) 44879	15 (DN8) 44879
Trigger gun with safety catch	Model Ord.no.	Starlet 3 12500	Starlet 3 12500
Lance with flat-jet nozzle	Nozzle Ord.no.	● 045 12420-D25045	● 045 12420-D25045
Water inlet filter	Ord.no.	13310	13310





ELECTRICALLY HEATED HOT WATER HIGH-PRESSURE CLEANERS

EMISSION-FREE, INSTANT HOT WATER AND IMPRESSIVELY THOROUGH CLEANING

Clean air, clean room: Our electrically heated high-pressure cleaners are especially suitable for use in closed rooms without exhaust air, in clean rooms or in health and hygiene sensitive areas. Temperatures of up to 80 °C increase the cleaning effect for stubborn dirt and the electrically operated instantaneous water heater enables emission-free working.

TABLE OF CONTENTS

 e-therm-Series	76-77
 Accessories for plug-in system D12	78-99

KEY INDUSTRIES





TECHNICAL HIGHLIGHTS



ELECTRICALLY HEATED INSTANTANEOUS WATER HEATER
Stable heat: the instantaneous water heater can be operated with up to 48 KW and enables even in continuous operation Temperatures up to 80 °C. It ensures a uniform water temperature and is therefore ideally suited for cleaning of fats and oils.



DIGITAL THERMOSTAT
The temperature is controlled via the digital thermostat. This allows the water temperature to be maintained at a constant level. An integrated operating hours counter determines the required service intervals.



INTEGRATED HOSE REEL
Space-saving and convenient: with a folding crank handle for practical, neat storage of the high-pressure hose. A special locking device holds the reel in the desired position.



 **ECO-MODE**
On a small "flame": with the Eco level, the user can keep the maximum working temperature at 55 °C and thus Reduce electricity consumption up to 50%.
(for e-therm 603 M 36, e-therm 873 M 36 and e-therm 873 M 48)

e-therm-Series



ACCESSORY STORAGE
neat storage for high pressure gun and lances

CONVENIENT INTEGRATED HOSE REEL (VARIANT)
space-saving storage of the high-pressure hose with twist stop screw connection

DIGITAL CONTROL PANEL
digital temperature regulation with 2 different operation modes

ECO LEVEL
for energy-saving use (e-therm 603 M 36, e-therm 873 M 36, e-therm 873 M 48)



e-therm 603 M 36 | 642260

► **ACCESSORIES** | page 78-99

EQUIPMENT

- Quick release plug-in system D12
- Kränzle axial pump
- Total-stop system with delayed motor cut-off
- Safety shutdown
- Pressure regulation
- Locking brake
- Water tank: Volume 12 liters (e-therm 603 M 36, e-therm 873 M 36, e-therm 873 M 48)

EQUIPMENT HOT WATER ELECTRICALLY HEATED

- Digital thermostat
- Flow monitor
- Overheating protection
- Operating hours mete





VARIANT - NON-MARKING

42280

NOM conversion kit Version without drum	Ord.no.	42280
NOM conversion kit Version with drum	Ord.no.	42281

For further information on NON-Marking please refer to page 79

MODEL	e-therm 500 M 18 e-therm 500 M 18 T	e-therm 500 M 24 e-therm 500 M 24 T	e-therm 603 M 36 e-therm 603 M 36 T	e-therm 873 M 36 e-therm 873 M 36 T	e-therm 873 M 48 e-therm 873 M 48 T
Ord.no. without hose drum	642050	642150	642250	642300	642350
Ord.no. incl. hose drum	642060	642160	642260	642310	642360

TECHNICAL SPECIFICATIONS

Operating pressure	bar MPa	30-130 3-13	30-130 3-13	30-150 3-15	30-150 3-15	30-150 3-15
Water output	l/min l/h	8 480	8 480	10 600	13 780	13 780
Admissible overpressure	bar MPa	150 15	150 15	170 17	170 17	170 17
Motor speed	Rpm	1400	1400	1400	1400	1400
Connection	V ~ Hz A	400 3 50 29	400 3 50 39	400 3 50 55	400 3 50 59	400 3 50 76
Power intake	kW	20	27	38	40	52
Power supply cable	m	5	5	5	5	5
Plug		CEE 32 A	CEE 63 A	CEE 63 A	CEE 63 A	CEE 125 A
Dimensions L x W x H without hose drum	mm	1050 800 1015	1050 800 1015	1050 800 1015	1050 800 1015	1050 800 1015
Dimensions L x W x H incl. hose drum	mm	1050 800 1450	1050 800 1450	1050 800 1450	1050 800 1450	1050 800 1450
Weight without incl. hose drum	kg	128 136	128 136	160 168	160 168	160 168

TECHNICAL DATA HOT WATER

Hot water delivery at 12 °C feed	°C	48	60	75	68	80
Heating output	kW	18	24	36	36	48

EQUIPMENT

High-pressure hose without hose drum	m Ord.no.	10 (DN8) 41081	10 (DN8) 41081	10 (DN8) 41081	10 (DN8) 41081	10 (DN8) 41081
High-pressure hose incl. hose drum	m Ord.no.	20 (DN8) 443812	20 (DN8) 443812	20 (DN8) 443812	20 (DN8) 443812	20 (DN8) 443812
Trigger gun with safety catch	Model Ord.no.	Starlet 3 12500	Starlet 3 12500	Starlet 3 12500	Starlet 3 12500	Starlet 3 12500
Lance with flat-jet nozzle	Nozzle Ord.no.	○ 03 12420-D2503	○ 03 12420-D2503	● 035 12420-D25035	● 05 12420-D2505	● 05 12420-D2505
Water inlet filter	Ord.no.	13310	13310	13310	13310	13310



WITH THE RIGHT TOOLS EVERYTHING IS ALWAYS UNDER CONTROL

Ready for use with one click: Our versatile range of accessories turns every Kränzle into an all-rounder for numerous areas of application. Whether surface or pipe cleaning, sandblasting work or particularly thorough cleaning with foam to loosen coarse dirt. All accessories are equipped with our quick-change plug-in system, which ensures the quick, easy and safe connection of cleaning lances and accessories.



TABLE OF CONTENTS

Conversion to plug-in system D12	80-81
Trigger guns with safety catch	82-83
Cleaning lances	84-89
Floor cleaners	90
Foam cleaning Additive	91
Telescopic Lance	92-93
Special accessories	94
Intake / extraction Filter	95
Wall holders	96
Lance holder Hose reels	97
Adapter	97
High-pressure hoses	98



TECHNICAL HIGHLIGHTS



QUICK RELEASE PLUG-IN SYSTEM

Sophisticated, fast and reliable: the quick release plug-in system with hardened stainless steel components ensures simple and always safe connection of the safety shut-off gun with the lance.



HEXAGONAL ANTI-ROTATION LOCK

Cleaning lances and accessories equipped with a hexagonal coupling can be locked against rotation in six different positions. This prevents the accessories from twisting unintentionally and allows them to be guided by moving the gun.



NON-MARKING EXECUTION (NOM)

Particularly suitable for use in hygiene and sanitary areas: The Kränzle NoM versions leave no traces or stripes, their abrasion resistance also ensures a longer service life of hoses and wheels.



TWIST-STOP SCREW CONNECTION

Go along with everything: provided with all machines: A special screw connection prevents the Twisting of the high-pressure hose during work and ensures so for consistent cleaning results in every situation.

AS SAFE AS EVER,

AS FAST AS NEVER BEFORE



CONVERSION TO PLUG-IN SYSTEM D12

The threaded connection has always been a guarantee for the reliable connection between safety shut-off gun and lances. With the innovative quick-change plug-in system, we have further developed this proven technology: The plug-in coupling combines the usual safety with additional comfort. By simply plugging in, the lances can be changed more conveniently and quickly than ever before.

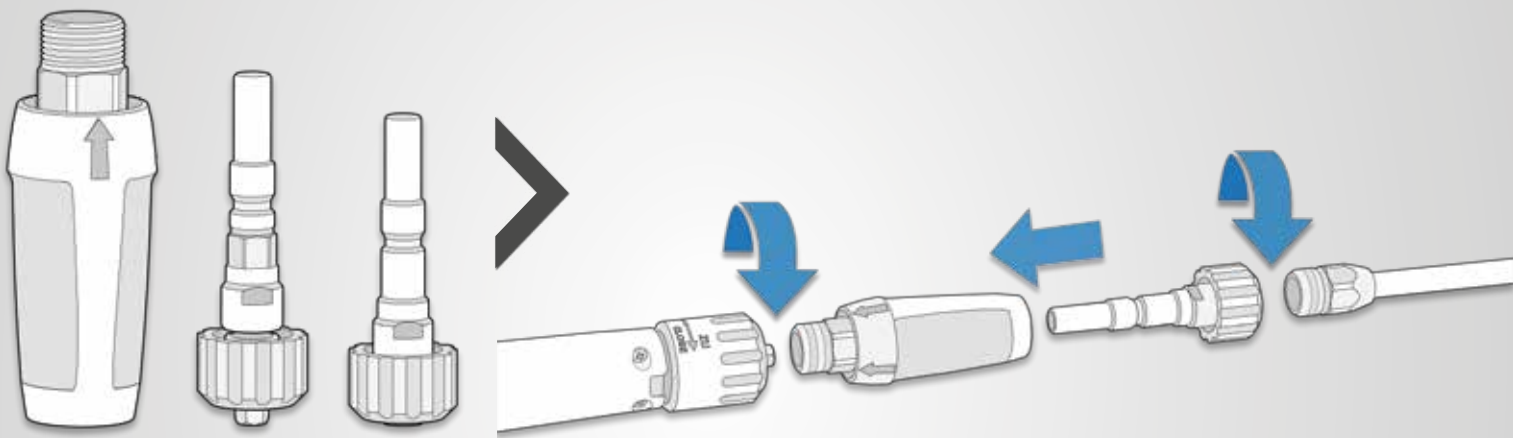

CONVERSION KIT | Ord.no. 13455

- Attachment plug-in system D12
- Plug nipple D12 with anti-twist protection
- Plug nipple D12 without anti-twist protection

CONVERSION MADE EASY

- Screw the attachment plug-in system onto the trigger gun M22
- Screw the accessories with the M22 threaded screw onto the plug nipple
- Snap the plug nipple into the attachment plug-in system

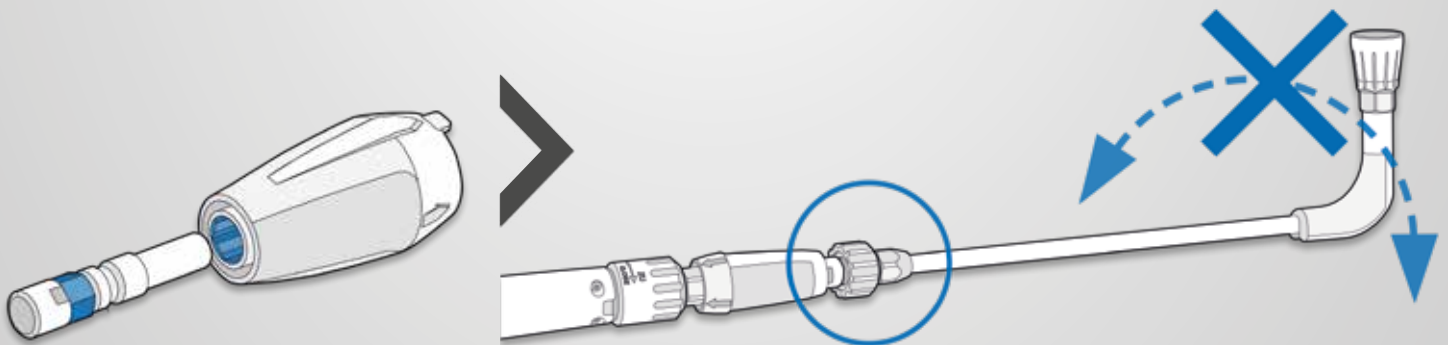

HEXAGONAL COUPLING

The external hexagon of the plug nipple with anti-twist protection fits perfectly into the internal hexagon of the Attachment plug-in system D12.

SECURED AGAINST TWISTING

Thanks to the plug-in nipple with hexagonal coupling, lances and accessories can be locked in six different positions. This makes unintentionally twisted accessories a thing of the past.

CONVERSION TO PLUG-IN SYSTEM D12



Conversion kit plug-in system D12

For converting trigger gun with safety catch and accessories with thread screw M22 to quick-change plug-in system D12.

Attachment plug-in system	Adapter 1	Adapter 2	Ord.no.
M22x1,5 AG ▶ D12	Plug nipple D12 without anti-twist protection	Plug nipple D12 with anti-twist protection	13455



124415

12440

Adapter Thread screw M22 ▶ plug-in system D12

For use of the accessories with thread screw M22 for trigger gun with safety catch with plug-in system D12

Inlet	Outlet	Anti-twist protection	Length mm	Ord.no.
Plug nipple D12	M22x1,5 IG	–	100	12441
Plug nipple D12	M22x1,5 IG	●	100	124415
Plug nipple D12	M22x1,5 IG	–	400 grip plates	12440

Attachment plug-in system D12

For converting trigger gun with safety catch to quick-change plug-in system D12.

Ord.no.	12443
Outlet	D12



ACCESSORIES THREAD SCREW M22

FOR DEVICES PRODUCED BEFORE 2020

Since 2020, all high-pressure cleaners will be equipped exclusively with the innovative quick-change plug-in system. The previous cleaning accessories with threaded fittings for existing Kränzle units are of course still available.

► **DOWNLOAD: ACCESSORIES CATALOGUE M22**

Scan QR code



WORKS AS WELL

AS IT LOOKS

STARLET 3

The Starlet 3 combines function and design for precise, smooth operation. The lightweight design of the safety shut-off gun makes it comfortable to hold for long periods of time and allows you to work comfortably in pressure ranges up to 270 bar and water flow rates up to 40 l/min.



TECHNICAL DATA

Outlet max.	plug-in system D12
Operating pressure max.	270 bar 27 MPa
Water output max.	40 l/min
Temperature max.	150 °C
Ord.no.	12500

TECHNICAL HIGHLIGHTS

- **COMPACT DESIGN**
with modern design for comfortable handling
- **ERGONOMIC HANDLE**
Conforms to the natural shape of your hand for fatigue-free use
- **SMOOTH-RUNNING TRIGGER**
for easier water flow control
- **HEXAGONAL ANTI-TWIST LOCK**
Allows anti-twist accessories to be locked in six different positions



COMFORT AND DURABILITY FOR THE PERFECT CLEANING EXPERIENCE

STARLET 4

The Starlet 4 gun combines quality and reliability for professional cleaning. The pressure washer offers comfortable handling and and comfort in operation control of the water flow thanks to its lightweight and robust design. Whatever your cleaning requirements may be the Starlet 4 is designed for a working pressure of 210 bar and a water flow of 20 l/min, making it the ideal choice for most cleaning tasks.



TECHNICAL DATA

Outlet max.	plug-in system D12
Operating pressure max.	210 bar 21 MPa
Water output max.	20 l/min
Temperature max.	100 °C
Ord.no.	12525

TECHNICAL HIGHLIGHTS

- **ERGONOMIC DESIGN**
for a secure and comfortable grip during the cleaning process
- **HEXAGONAL ANTI-TWIST LOCK**
for locking accessories in six different positions
- **ERGONOMIC HANDLE**
for fatigue-free operation
- **SMOOTH TRIGGER ACTION**
Requires less effort



CLEVER NOZZLE TECHNOLOGY



FOR MAXIMUM

CLEANING POWER

LANCE WITH PENDULUM NOZZLE

Convinces even under the toughest conditions: The new cleaning lance with pendulum nozzle made of wear-free stainless steel removes the most stubborn dirt and at the same time ensures area-wide cleaning. Its intelligent design combines the advantages of a flat jet lance with the power of a spot jet. An oscillating water jet delivers excellent cleaning results with significantly increased rinsing/spraying performance.

- produces a unique fluid jet (Coandă effect)
- without moving parts, thus robust and durable
- saves energy and water due to faster cleaning
- low vibrations and noise development

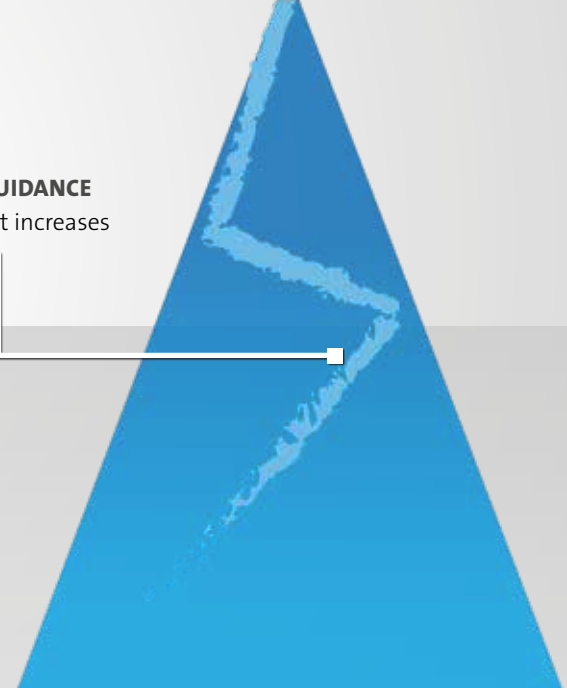

INTELLIGENT FLOW GUIDANCE
the oscillating point jet increases the cleaning power

PRACTICALLY INDESTRUCTIBLE
made of stainless steel



CLEANING LANCES



12424-PD3008

Lance with pendulum nozzle

- grip plates

Length	mm	Nozzle size	Spraying angle	Ord.no.
1000		05	30°	12424-PD3005
1000		07	30°	12424-PD3007
1000		08	30°	12424-PD3008
1000		11	30°	12424-PD3011







CLEANING LANCES



12435-M20028

Lance with flat jet nozzle				
Length	mm	Nozzle size	Spraying angle	Ord.no.
500		○ 028	20°	12435-M20028
500		○ 03	20°	12435-M2003
500		● 042	20°	12435-M20042
500		● 045	20°	12435-M20045
500		1/4" female, without nozzle **	without nozzle **	12435-XXX

FLAT JET NOZZLE

Our recommendation for cleaning sensitive surfaces. The flat spray nozzle with its conical jet (spraying angle: 20 - 40°) works particularly well and even produces a sweeping effect to push dirt and debris away from the cleaning area.



12420-D2503



Lance with flat jet nozzle

■ grip plates

Length	mm	Nozzle size	Spraying angle	Ord.no.
1000		○ 03	25°	12420-D2503
1000		● 035	25°	12420-D25035
1000		● 04	25°	12420-D2504
1000		● 045	25°	12420-D25045
1000		● 05	25°	12420-D2505
1000		● 055	25°	12420-D25055
1000		● 06	25°	12420-D2506
1000		● 065	25°	12420-D25065
1000		● 07	25°	12420-D2507
1000		● 075	25°	12420-D25075
1000		● 08	25°	12420-D2508
1000		● 085	25°	12420-D25085
1000		● 11	25°	12420-D2511
1000		● 125	25°	12420-D25125
1000		● 05	40°	12420-D4005
1000		● 06	40°	12420-D4006
1000		● 065	40°	12420-D40065
1000		● 08	40°	12420-D4008
1000		● 085	40°	12420-D40085
1000		● 11	40°	12420-D4011
1000		● 125	40°	12420-D40125
1000		15	40°	12420-D4015
1000		175	40°	12420-D40175
1000		20	40°	12420-D4020
1000		1/4" female, without nozzle **	without nozzle **	12420-XXX
1250		1/4" female, without nozzle **	without nozzle **	124220-XXX
1500		1/4" female, without nozzle **	without nozzle **	124210-XXX



SPRAY ANGLE NOZZLES

- 
20° SPRAYING ANGLE
 Knife nozzle
 Material: Brass
- 
25° SPRAYING ANGLE
 Flat-jet nozzle
 Material: Stainless steel
- 
40° SPRAYING ANGLE
 Flat-jet nozzle
 Material: Stainless steel

**Please order high-pressure nozzle separately.



CLEANING LANCES

VARIO-JET

The spray pattern can be adjusted from pointed jet to a wide spray fan. In addition, for high-pressure cleaners with an integrated chemical injector, the Vario-jet lance has an adjustable nozzle that allows the user switch from spraying water to spraying detergent. As such, cleaning foam or detergent can be applied without the need to change accessories.



VARIO-JET DUO

The spray pattern can be adjusted from pointed jet to a wide spray fan.

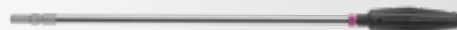

Lance with Vario-Jet			
■ with anti-twist protection			
Length	mm	Nozzle size	Ord.no.
500		● 028	12437-028
500		○ 03	12437-03
500		● 042	12437-042

Lance with Vario-Jet Duo			
Length	mm	Nozzle size	Ord.no.
500		● 028	12433-028
500		○ 03	12433-03
500		● 042	12433-042

12436-M20042



Stainless steel lance with regulating nozzle				
■ max. 250 bar 25 MPa		■ max. 150 °C		■ with anti-twist protection
Length	mm	Nozzle size	Spraying angle	Ord.no.
500		● 042	20°	12436-M20042
500		○ 03	20°	12439-D2503
500		● 05	20°	12439-D2505

12431-D2503



Stainless steel lance with regulating nozzle				
■ max. 250 bar 25 MPa		■ max. 150 °C		■ with grip plates
Length	mm	Nozzle size	Spraying angle	Ord.no.
1000		○ 03	25°	12431-D2503
1000		● 045	25°	12431-D25045
1000		● 05	25°	12431-D2505
1000		● 07	25°	12431-D2507
1000		R 1/4" IG, without nozzle **	without nozzle **	132061
1500		R 1/4" IG, without nozzle **	without nozzle **	132062

132051



132060



Short regulating nozzle				
Length	mm	anti-twist protection	Nozzle size	Ord.no.
180		●	R 1/4" IG, without nozzle **	132051
340		grip plates	R 1/4" IG, without nozzle **	132060

LANCE WITH CONTROL NOZZLE

The working pressure can be set directly on the lance and for different tasks settings, for example more powerful flat jet with high pressure or more practical rinsing jet in low pressure operation.



****Please order high-pressure nozzle separately.**



CLEANING LANCES



12438-028

Lance with Dirtkiller

- Water output max. 15 l/min
- Operating pressure max. 180 bar | 18 MPa

Length	mm	Nozzle size	Ord.no.
500		○ 028	12438-028
500		○ 03	12438-03
500		● 042	12438-042
500		● 045	12438-045
500		● 05	12438-05
500		● 055	12438-055



12425-042

Lance with Dirtkiller

- Water output max. 15 l/min
- Operating pressure max. 180 bar | 18 MPa
- grip plates

Length	mm	Nozzle size	Ord.no.
1000		○ 03	12425-03
1000		● 035	12425-035
1000		● 042	12425-042
1000		● 045	12425-045
1000		● 05	12425-05
1000		● 055	12425-055
1000		● 06	12425-06
1000		● 07	12425-07
1000		● 075	12425-075

DIRTKILLER AND TURBOKILLER

On insensitive surfaces the high pressure nozzle of the dirt killer with its rotating ceramic ball, removes even the most stubborn stains without residue. The turbokiller comes into its own when in most challenging cleaning assignments.



Figure: Dirtkiller

Figure: Turbokiller



12430-045

Lance with Turbokiller

- grip plates

Length	mm	Nozzle size	Ord.no.
1000		● 035	12430-035
1000		● 04	12430-04
1000		● 045	12430-045
1000		● 05	12430-05
1000		● 055	12430-055
1000		● 07	12430-07
1000		● 08	12430-08
1000		● 09	12430-09
1000		● 10	12430-10
1000		● 11	12430-11
1000		12	12430-12



****Please order high-pressure nozzle separately.**



CLEANING LANCES

410756

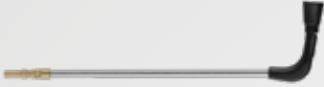

Underbody lance

For hard-to-reach areas
 ■ with anti-twist protection

Length	mm	Nozzle size	Ord.no.
500		● 07	410756

410755

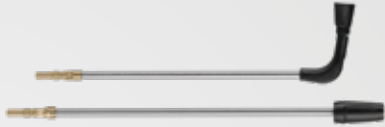

Underbody lance

For hard-to-reach areas
 ■ with anti-twist protection

Length	mm	Nozzle size	Ord.no.
1000		● 07	410755



Toilet lance

■ with anti-twist protection ■ with regulating nozzle

Ord.no.	12540
Length	mm 500
Nozzle size	D25055



Bend lance with handgrip

Infinite adjustment of bending angle from 20° to 140°

Ord.no.	121801-XXX
Length	mm 1100
Outlet	R 1/4" IG, without nozzle **

121332



Double lance with turning hand-grip

Infinite variable control of working pressure
 ■ with anti-twist protection

Length	mm	Nozzle size	Ord.no.
660		D3035 **	121332

12133



Double lance with turning hand-grip

Infinite variable control of working pressure

Length	mm	Nozzle size	Ord.no.
1000		D3035 **	12133

125301



Double lance with turning knob

Infinite variable control of working pressure
 ■ with anti-twist protection

Length	mm	Nozzle size	Ord.no.
660		D3035 **	125301

125302



Double lance with turning knob

Infinite variable control of working pressure

Length	mm	Nozzle size	Ord.no.
1000		D3035 **	125302

411545



Lance extension

■ with anti-twist protection

Length	mm	Outlet	Ord.no.
342		Plug nipple D12	411544
500		Plug nipple D12	411545

411547



Lance extension

■ grip plates

Length	mm	Outlet	Ord.no.
1000		Plug nipple D12	411546
1250		Plug nipple D12	411547
1500		Plug nipple D12	411548

** Low-pressure nozzle serially included. Order high-pressure nozzle separately.



FLOOR CLEANERS



Round Cleaner UFO short

for small to medium-sized surfaces

Ord.no.	41855	
+ Adapter D12	12441	
Inlet	M22x1.5 AG	
Ø	mm	300
Operating pressure	bar MPa	180 18
Water output max.	l/min	12
Weight	kg	1.9
Nozzle size	045	



Round Cleaner UFO long

for small to medium-sized surfaces

Ord.no. without wheels	41880	
Ord.no. with wheels	41881	
Ø	mm	300
Operating pressure	bar MPa	180 18
Water output max.	l/min	12
Weight without wheels	kg	2.4
Weight with wheels	kg	3.1
Nozzle size	045	



Round Cleaner UFO long stainless steel

for small to medium-sized surfaces

Ord.no. Nozzle size 045	41891	
Ord.no. Nozzle size 055	41890	
Ø	mm	350
Operating pressure	bar MPa	210 21
Water output max.	l/min	15
Weight	kg	5.5



Round Cleaner INOX 300

for medium-sized to large surfaces

Ord.no.	41813	
Ø	mm	300
Operating pressure	bar MPa	160 16.0
Water output max.	l/min	12
Weight	kg	2.9
Nozzle size	045	



Round Cleaner INOX 410

for large to very large surfaces

Ord.no.	41814	
Ø	mm	410
Operating pressure	bar MPa	180 18.0
Water output max.	l/min	14
Weight	kg	3.6
Nozzle size	045	



Round Cleaner INOX 520

for large to very large surfaces

Ord.no.	41812	
Ø	mm	520
Operating pressure	bar MPa	220 22.0
Water output max.	l/min	26
Weight	kg	11.4
Nozzle size	06	

** When used with Starlet 3, the lance extension Ord.no. 411544 is required.



FOAM CLEANING | ADDITIVE



135303



135313

Foam lance

Production of highly effective foam

- adjustable spraying angle (spot jet - flat-jet)
- incl. screw cap

Container	Liter	Ord.no.
1		135303
2		135313



SPOT JET

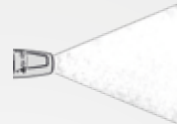

FLAT-JET

1 Liter



2 Liter

Spare container foam lance

For changing and storing cleaning agents

Container without lid	Ord.no.
1 Liter	135320
2 Liter	135321
Screw cap	135336

412710



412711

412721



412731



Kränzle Neutral

Universal cleaner for removal of strong contaminations

- pH value****: 8.5

Container	Liter	Ord.no.
1		412710
5		412711
25		412712

Kränzle Plus

Special cleaner to degrease and clean

- pH value**: 10.5

Container	Liter	Ord.no.
5		412721
25		412722

Kränzle Marine

Highly alkaline intensive cleaner dissolves soot, oil and grease stains

- pH value**: 11.0

Container	Liter	Ord.no.
5		412731
25		412732



Decalcifying (concentrate)

Descaling of water high-pressure cleaners
Removal of lime deposits

- pH value**: 1.0

Container	Liter	Ord.no.
1		412580
12 x 1		412570



High-performance transmission oil

For all Kränzle high pressure pumps

Container	Liter	Ord.no.
0.25		400931
1		400932
5		400933
20		400934



Important note:

When using chemical cleaning agents, observe the respective regulations, provisions, safety notes and safety data sheets.

Safety data sheets under: www.kraenzle.com/sda

**pH value: Undiluted

We recommend testing the cleaning agent on the surface to be cleaned before starting.

POWERFUL TOOL FOR PROFESSIONAL CLEANING WORK

TELESCOPIC LANCE

The telescope lance offers a convenient and effective solution for cleaning hard-to-reach places at great heights. With this telescope lance, you can work without scaffolding or a lifting platform and safely clean various surfaces from the ground, including facades, ceilings, glass surfaces and solar installations.



CARRYING STRAP

As an option, the telescopic lance can be supplied with a carrying or shoulder strap to make transport and handling even more repeated comfortable.

Ord.no. 122100



Telescopic lance

For easy cleaning of hard-to-reach places at great heights. Clean without scaffolding or lifting platform - safely from the ground.

Ord.no.		121900
Inlet/Outlet		M22x1.5 AG
Length min. max.	m	2.4 5.4
Operating pressure with cleaning brush max.	bar MPa	40 4
Water output max.	l/min	30



Cleaning brush transverse

EXPERT TIP

- Natural bristles
- Connection M22x1.5 AG

Ord.no.	410500
----------------	---------------





SPECIAL ACCESSORIES



128060

Cleaning brush transverse

- Natural bristles
- Brush head LxW: 240x90 mm
- with anti-twist protection (500 mm)

Pipe length	mm	Ord.no.
500		128060
750		128061



128062

Cleaning brush transverse

- Natural bristles
- Brush head LxW: 240x90 mm
- with grip plates

Pipe length	mm	Ord.no.
1000		128062
1250		128063
1500		128064



optional

Cleaning brush flat

- Plastic bristles

Ord.no.	41073
+ Adapter D12	12441
Inlet	M22x1.5 AG
Dimensions LxW mm	180x65

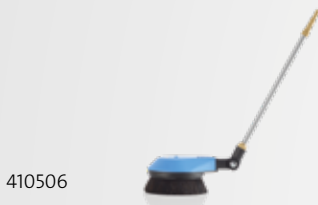

410506

Rotating washing brush

- Natural bristles
- Brush head Ø: 180 mm
- with anti-twist protection

Pipe length	mm	Ord.no.
342		410506



410507

Rotating washing brush

- Natural bristles
- Brush head Ø: 180 mm
- with grip plates

Pipe length	mm	Ord.no.
1000		410507
1250		410508
1500		410509



Spray guard

- For cleaning surfaces without splashing water
- Applicable for all washing lances

Ord.no.	132600
Dimensions LxW mm	285x190



optional

Sandblaster set (wet blasting)

- for blasting sandstone and facades
- with hose and intake lance

Ord.no.	41068
+ Adapter D12	12441
Inlet	M22x1.5 AG
Operating pressure bar MPa	250 25
Water output l/min	19
for blasting material mm	0.2 - 2.0
Nozzle size	● 055

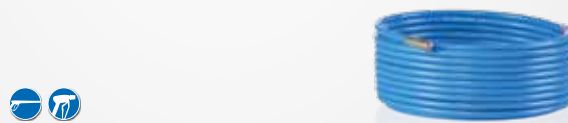

Pipe cleaning hose with nozzle

- Operating pressure max.: 200 bar | 20 MPa
- Nozzle size without front bore: KN 055
- other nozzles on request**
- Nozzle size with front bore: KNF 055

Length m	Ord.no. without front bore	Ord.no. with front bore
10	12550	12550-F
15	125501	125501-F
20	125502	125502-F
25	125503	125503-F
30	125504	125504-F



WITHOUT FRONT BORE

3 jets to the rear



WITH FRONT BORE

3 jets to the rear
1 jet to the front

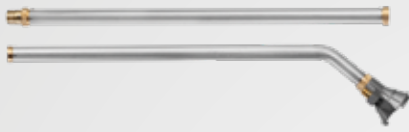

Sludge sucker

Extraction of mud from pools and ponds
 ■ For high-pressure cleaners from 10 l/min

Ord.no.	41791	
Inlet	M22x1.5 AG	
Length	m	2
Operating pressure max.	bar MPa	250 25
Water output max.	l/min	20
Suction height max.	m	3
Suction power at 130 bar / 220 bar	l/h	10000 17500
Nozzle size (factory fitted)	● 055	



Sludge sucker

Extraction of mud from pools and ponds
 ■ For high-pressure cleaners from 10 l/min
 ■ hose diameter 1 1/2 "

Ord.no.	41104	
Inlet	M22x1.5 AG	
Hose length	m	3.8
Operating pressure max.	bar MPa	250 25
Water output max.	l/min	20
Suction height max.	m	3
Suction power at 130 bar / 220 bar	l/h	10000 17500
Nozzle size (factory fitted)	● 055	



Pool cleaner attachment

Attachment for stainless steel mud extractor

Ord.no.	418030	
Inlet	M22x1.5 AG	
Dimensions L	mm	320
Operating pressure max.	bar MPa	250 25
Water output max.	l/min	20
Suction height max.	m	3
Suction power at 130 bar / 220 bar	l/h	10000 17500
Nozzle size as standard	● 055	



Suction hose with suction filter

■ with return valve
 ■ For high-pressure cleaners from 10 l/min

Ord.no.	150383	
Inlet	3/4" IG	
Hose length	m	3



133003

133201

Water inlet filter

■ Inlet and outlet in brass execution, except article: 13310

Inlet	Outlet	Ord.no.
3/4" AG (Plastic connection)	3/4" IG (Screw connection)	13310
3/4" AG	3/4" IG (Screw connection)	133003
Quick release coupling with claws (GEKA)	Quick release coupling with claws (GEKA)	133005
3/4" AG	3/4" IG (Screw connection)	133201



EVERYTHING IN PLACE

ACCESSORIES ORGANISER

The search is over: with the correct accessories, Kränzle gives you the versatility to clean even the most difficult jobs. To ensure that all utensils are always within reach and that you don't lose track of them, Kränzle offers a variety of practical storage solutions. These are compatible with the complete range of Kränzle accessories - also for accessories with M22 threaded screw connection.

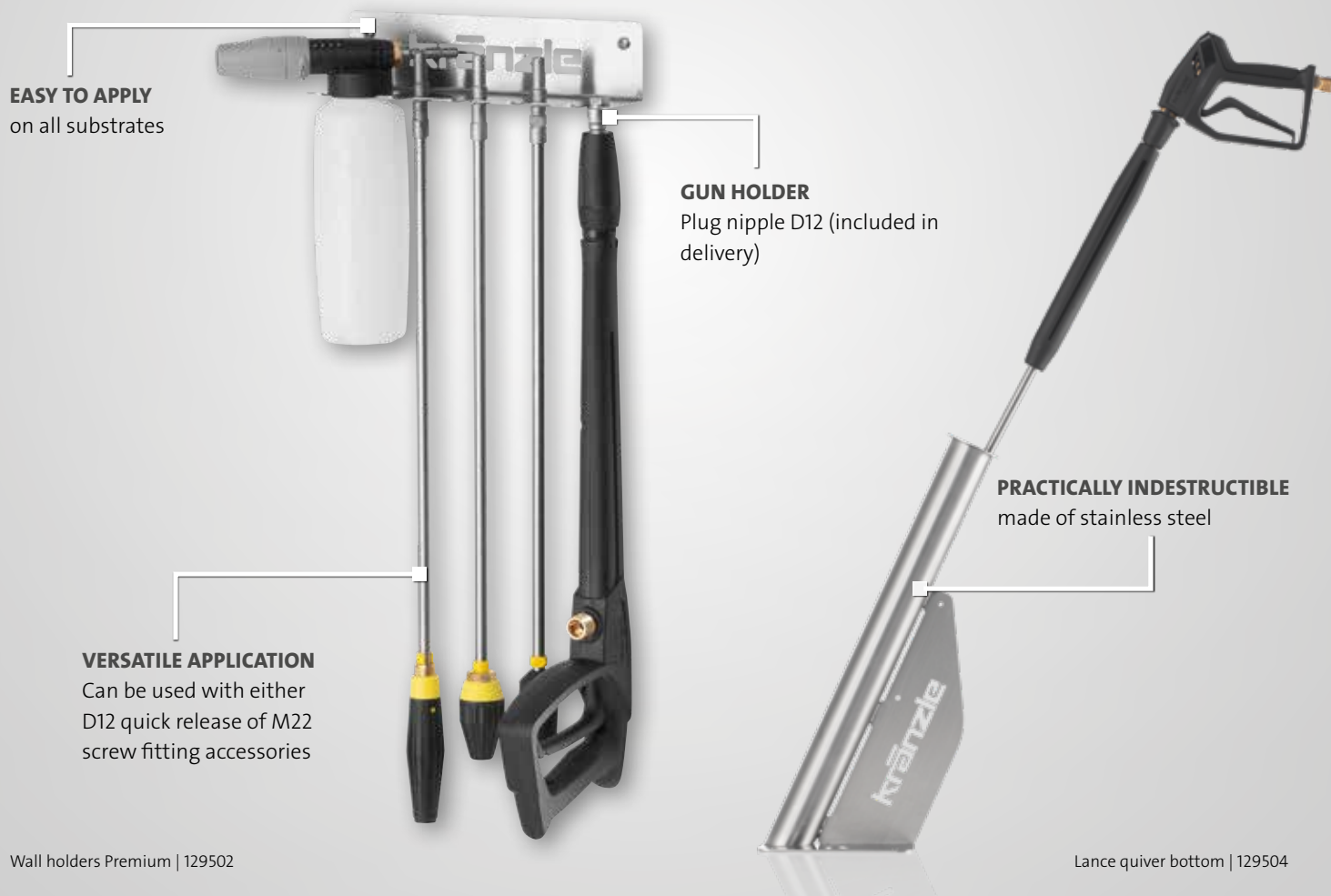

EASY TO APPLY
on all substrates

GUN HOLDER
Plug nipple D12 (included in delivery)

VERSATILE APPLICATION
Can be used with either D12 quick release or M22 screw fitting accessories

PRACTICALLY INDESTRUCTIBLE
made of stainless steel

Wall holders Premium | 129502

Lance quiver bottom | 129504

WALL HOLDERS



Wall holders Lances

Space-saving storage of up to seven lances and washing brushes
■ incl. gun holder D12

Ord.no.	129500
Dimensions LxWxH mm	300x50x70



Wall holders Foam lance

Large trough for practical attachment of the Foam lance

Ord.no.	129501
Dimensions LxWxH mm	80x70x70



Wall holders Premium

For the storage of up to four cleaning lances and one foam lance
■ incl. gun holder D12

Ord.no.	129502
Dimensions LxWxH mm	300x70x70

ACCESSORIES

LANCE HOLDER | HOSE REELS



Lance quiver bottom

For floor mounting, with leakage connection
 ■ Suitable for stowing 2 lances

Ord.no.	129504	
Pipe length	mm	590
∅	mm	55



Lance quiver wall

For wall mounting
 ■ not suitable for lances with turbo killer

Ord.no.	129505	
Pipe length	mm	590
∅	mm	55



Retrofit parts for automatic hose reel

■ therm-RP, therm-1, therm 1017

Ord.no.	48950	
HP hose	m	20 (DN8)



Automatic hose reel

■ incl. connection hose 2 m

Ord.no.	43855	
HP hose	m	20 (DN8)



Automatic hose reel stainless steel

■ incl. connection hose 2 m

incl. HP hose	m	Ord.no.
20 (DN8)		412681
30 (DN8)		412691

ADAPTER



Conversion kit - flow monitor

For leakage protection in the pipe network.
 Suitable for non-monitored areas

Ord.no.	126342	
Flow rate	l/min	4



Pipe ventilation with non-return valve

Installation between device and drinking water pipe
 ■ with return valve

Ord.no.	410164	
Inlet	3/4" IG	
Outlet	3/4" AG	



44192

Chimney adapter

For indoor installations
 ■ for all oil-heated therm-Series
 ■ ∅ 200 mm

Length	mm	Ord.no.
200		44192
385		441921

HIGH PRESSURE HOSES



43416 Standard

NoM 410841

Steel braided high-pressure hose

■ Inlet | Outlet: M22x1.5 IG ■ Rotating screw connection ■ Bend protection *Other versions on request*

Length	m	Steel braided layers	SN	Operating pressure	bar MPa	Temperature max.	°C	Ord.no. Standard	Ord.no. NoM
10 (DN6)	1			210 21		100		43416	434162
20 (DN6)	1			210 21		100		434161	434163
10 (DN8)	1			230 23		150		44878	–
10 (DN8)	2			400 40		150		41081	410811
15 (DN8)	1			230 23		150		44879	–
15 (DN8)	2			400 40		150		–	410821
25 (DN8)	2			400 40		150		41084	410841
30 (DN8)	2			400 40		150		41080	410801



443812 Standard

NoM 410831

Replacement hose - for high-pressure cleaners with hose reel

■ Outlet: M22x1.5 IG ■ Rotating screw connection ■ Bend protection *Other versions on request*

Device series	Length	m	Steel braided layers	SN	Operating pressure	bar MPa	Temperature max.	°C	Ord.no. Standard	Ord.no. NoM
K 1152, K 2000	15 (DN6)		1		210 21		100		48015	480151
Profi	15 (DN6)		1		210 21		100		43829	438291
small quadro	15 (DN6)		1		210 21		100		40170	401701
quadro 599/799	20 (DN6)		1		210 21		100		434161	434163
quadro 899	15 (DN8)		1		210 21		100		44879	410821
bully	15 (DN8)		1 / NoM: 2		210 21 / NoM: 400 40		100		46411	464111
large quadro, Profi-Jet, B, Primus AT	20 (DN8)		2		400 40		150		41083	410831
therm C, therm CA	15 (DN8)		1 / NoM: 2		210 21 / NoM: 400 40		150		44879	410821
LX-RP, therm-RP, therm 1, e-therm, Primus, Primus-RP	20 (DN8)		2		400 40		150		443812	443813



412651



Connecting hose

■ Inlet | Outlet: M22x1.5 IG

Length	m	Steel braided layers	SN	Operating pressure	bar MPa	Ord.no.
1 (DN8)		2		400 40		41265
2 (DN8)		2		400 40		412651

Hose connector / joining piece

Ord.no.	13286
Inlet	M22x1.5 AG
Outlet	M22x1.5 AG

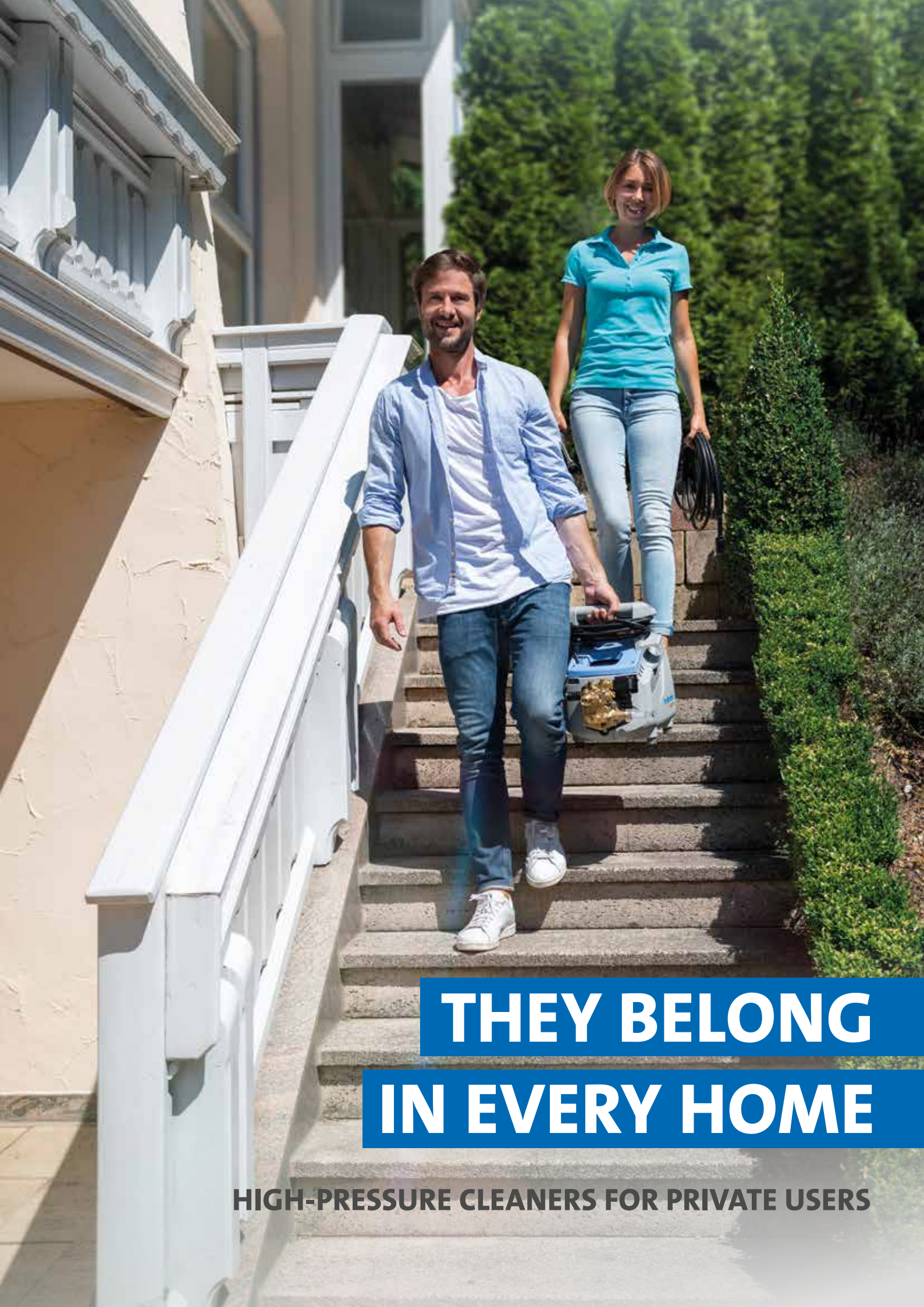

**THEY BELONG
IN EVERY HOME**

HIGH-PRESSURE CLEANERS FOR PRIVATE USERS

HIGH-PRESSURE CLEANERS FOR PRIVATE USERS

EXCEPTIONAL QUALITY FOR YOUR HOME

High-quality technology attractively packaged: Kränzle offers the K 1050-Series for demanding domestic tasks. The devices are characterised on the outside by a shapely and compact housing, in the inside are the sophisticated features and quality materials of our professional cleaning equipment. A well thought out range of accessories makes the cleaners real all-rounders.



TECHNICAL HIGHLIGHTS



QUICK RELEASE PLUG-IN SYSTEM D10

Sophisticated, fast and reliable: The quick release plug-in system with hardened stainless steel components ensures simple and safe connection of the safety shut-off gun with the lance.



INTELLIGENT SOLUTIONS FOR DOMESTIC USERS

First-class and functional: Kränzle high pressure cleaners can also be used for private users who expect only the best. Many of the components from the professional range for example the Brass pump head, stainless-steel plungers and roto-moulded chassis are used in the Kränzle 1050 range.



TOTAL-STOP SYSTEM

Full control: The Total stop system turns the motor on when the trigger gun is engaged and off when the trigger is released. This makes the machine more efficient and economical with less noise and reduced wear.



HOSE REEL

Practical and comfortable: After washing, the high-pressure hose can neatly and safely stored away thanks to the heavy-duty hose drum and crank handle.



COMPACT DESIGN

The ideal union of form and function: Not only for the performance features, but also in terms of mobility Kränzle has thought about the handling. The devices are easy to transport and thanks to the compact Housing shape it is neat and space-saving.



MANY POSSIBILITIES OF USE

No application without a Kränzle: Thanks to a wide range of accessories the powerful High pressure cleaners are equipped in such a way that they will be available for almost every Cleaning task in and around the house.



Quickly

NEW

ACCESSORIES STORAGE

for convenient stowage of the accessories and the power cable

PRACTICAL HOSE HOLDER

for tidy storage of the high-pressure hose

**INCLUDING FLOOR CLEANER
ROUND CLEANER UFO**

for simple and efficient cleaning of driveways, terraces and co

TRAY FOR WORK BREAKS

clever holder for the high-pressure gun during work breaks

**OFF-ROAD CAPABILITY
AND STABILITY**

robust chassis for easy transport and high stability

TOTALSTOP-SYSTEM

switches off the pump if the high-pressure gun is not operated during work breaks

► **ACCESSORIES** | page 108

EQUIPMENT

-  Quick release plug-in system D10
- Kränzle axial pump
- Total-stop system
- Water inlet filter
- High-pressure hose





MODEL	Quickly	NEW
Ord.no.	497500	

TECHNICAL SPECIFICATIONS

Operating pressure	bar MPa	130 13
Water output	l/min l/h	6.3 380
Admissible overpressure	bar MPa	145 14.5
Motor speed	Rpm	2800
Connection	V ~ Hz A	230 1 50 7.9
Power intake Power output	kW	1.8 1.35
Power supply cable	m	5
Dimensions L x W x H	mm	420 285 900
Weight	kg	20

EQUIPMENT

High-pressure hose	m Ord.no.	8 (DN6) 497070
Trigger gun with safety catch	Model Ord.no.	Starlet 4 12520
Lance with flat-jet nozzle	Nozzle Ord.no.	● 028 12900-028
Lance with Dirtkiller	Nozzle Ord.no.	● 028 42403-028
Round Cleaner UFO	∅ mm Ord.no.	260 41870
Water inlet filter	Ord.no.	13311



K 1050-Series



ROTO-MOULD CHASSIS

practically indestructible plastic housing

CONVENIENT INTEGRATED HOSE REEL (TST)

space-saving storage of the high-pressure hose - with foldable crank

ACCESSORY STORAGE

neat storage for high pressure gun and lances

CARRY HANDLE

portable and space-saving compact design

OFF-ROAD CAPABILITY AND STABILITY

robust chassis for easy transport and high stability



K 1050 TST | 495101
K 1050 P | 49501

► **ACCESSORIES** | page 108

EQUIPMENT

-  Quick release plug-in system D10
- Kränzle axial pump
- Total-stop system
- Water inlet filter

MODELS

- K 1050 P - portable
- K 1050 TS - mobile with hose support
- K 1050 TST - mobile with hose drum





MODEL	K 1050 P	K 1050 TS	K 1050 TST
Ord.no.	49501	495051	495101

TECHNICAL SPECIFICATIONS

Model		portable	with hose holder	with hose drum
Operating pressure	bar MPa	130 13	130 13	130 13
Water output	l/min l/h	7.5 450	7.5 450	7.5 450
Admissible overpressure	bar MPa	160 16	160 16	160 16
Motor speed	Rpm	2800	2800	2800
Connection	V ~ Hz A	230 1 50 9.6	230 1 50 9.6	230 1 50 9.6
Power intake Power output	kW	2.2 1.65	2.2 1.65	2.2 1.65
Power supply cable	m	5	5	5
Dimensions L x W x H	mm	390 290 370	340 350 860	340 350 860
Weight	kg	21	23	26

EQUIPMENT

High-pressure hose	m Ord.no.	8 (DN6) 410541	8 (DN6) 410541	12 (DN6) 49116
Trigger gun with safety catch	Model Ord.no.	Starlet 4 12520	Starlet 4 12520	Starlet 4 12520
Lance with flat-jet nozzle	Nozzle Ord.no.	○ 03 12900-03	○ 03 12900-03	○ 03 12900-03
Lance with Dirtkiller	Nozzle Ord.no.	optional	○ 03 42403-03	○ 03 42403-03
Water inlet filter	Ord.no.	13311	13311	13311



OPTIMALLY EQUIPPED FOR EVERY TASK

House, yard and garden always tip-top: a high-pressure cleaner is suitable for many jobs where thorough cleaning is required. With the versatile Kränzle accessories programme, users can extend the range of applications even further - whether leaves from the gutter or the moss in the driveway has to be removed, the bicycle needs a wash or the clogged drain is causing problems.

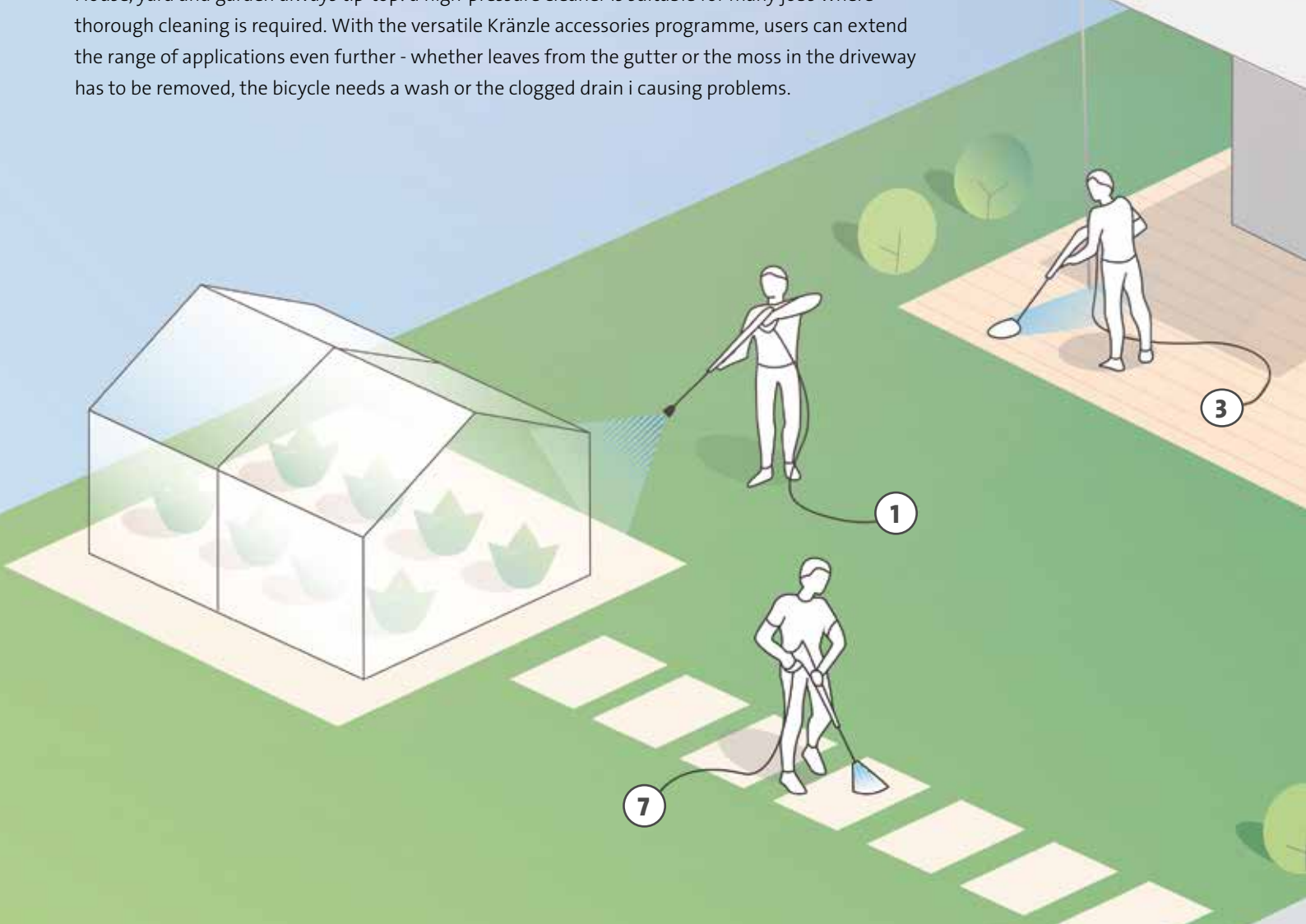

TECHNICAL HIGHLIGHTS

QUICK RELEASE PLUG-IN SYSTEM D10

Sophisticated, fast and reliable: The quick release plug-in system with hardened stainless steel components ensures simple and safe connection of the safety shut-off gun with the lance.

ANTI-TWIST PROTECTION

Accessories equipped with an anti-rotation device can be locked in different positions. This prevents the accessories from twisting unintentionally and allows them to be guided by moving the gun.





1. ROTATING DIRTKILLER NOZZLE:

Generates a rotating spot jet that removes even the most stubborn dirt

2. LANCE EXTENSION:

Makes ladder and co. unnecessary. For easy access to hard-to-reach places

3. ROUND CLEANER UFO:

With two rotating high-pressure nozzles for easy and efficient cleaning of larger areas such as driveways or patios lub tarasy

4. ROTATING WASHING BRUSH:

The soft bristles of the washing brush allow for a gentle cleaning of sensitive surfaces

5. PIPE CLEANING HOSE:

Hose with 10 metre length for easy access to and effective removal of blockages in pipes and drains

6. FOAM LANCE:

Produces effective foam to dissolve coarse soiling (combined with Kränzle Neutral)

7. SPLASH GUARD:

Transparent attachment that encloses the high-pressure jet and protects the surroundings from splashing water

ACCESSORIES | QUICK RELEASE PLUG-IN SYSTEM D10

FOR K 1050-SERIES AND QUICKLY



NEW



Starlet 4

- For K 1050-Serie and Quickly
- Inlet: M22x1.5 AG
- Outlet: Plug-in connection D10

Ord.no.	12520
----------------	--------------



12900-03

Lance with flat jet nozzle

- For normal dirt

Length	mm	Nozzle size	Ord.no.
400		● 028	12900-028
400		○ 03	12900-03



42403-03

Dirtkiller lance

- For stubborn dirt

Length	mm	Nozzle size	Ord.no.
400		● 028	42403-028
400		○ 03	42403-03



Lance extension

- Anti-twist protection

Ord.no.	12870
Length	mm 400



Round Cleaner UFO

Ord.no.	41870
∅	mm 260



Spray guard

- Applicable for all washing lances

Ord.no.	132600
Dimensions LxW	mm 285x190



Rotating washing brush

- Anti-twist protection

Ord.no.	12800
Brush head ∅	mm 180
Pipe length	mm 210



Pipe cleaning hose

Ord.no.	12850
Length	m 10



SPOT JET

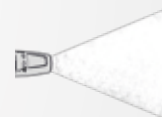

FLAT-JET



125312

Foam lance

- Adjustable from spot jet to flat jet

Ord.no. 1 Liter	135302
Ord.no. 2 Liter	135312



412710

Kränzle Neutral

- Universal cleaner for removal of strong contaminations
- pH value**: 8.5

Container	Liter	Ord.no.
1		412710
5		412711



412721

Kränzle Plus

- Special cleaner to degrease and clean
- pH value**: 10.5

Container	Liter	Ord.no.
5		412721
25		412722



412731

Kränzle Marine

- for cleaning motors
- alkaline
- pH value**: 11.0

Container	Liter	Ord.no.
5		412731
25		412732

**pH value: Undiluted. We recommend testing the cleaning agent on the surface to be cleaned before starting.



**BRILLIANT RESULTS
EVEN WITHOUT
WATERPOWER**

INDUSTRIAL VACUUM CLEANERS | HAND POWER SWEEPERS

INDUSTRIAL VACUUM CLEANERS

VERSATILE, POWERFUL AND COMFORTABLE

From the construction site to the salesroom to the workshop. The Ventos wet and dry vacuum cleaner, with integrated tool socket, is ideally equipped for all cleaning tasks. An automatic start-up, an automatic switchoff in case of the suction of liquids and the large drain plug ensure safe operation. The extra-long power cable and the suction hose offer a large action radius, and a wide range of accessories enables a thorough work.



TABLE OF CONTENTS

Ventos-Series	112-113
Accessories	114-115

KEY INDUSTRIES



THE FILTER CLEANING MAKES THE DIFFERENCE



MANUAL FILTER CLEANING – VENTOS PC-MODELS

The manual Push-Clean feature of the Ventos PC ensures constant suction power and optimum cleaning performance. After pressing the push button, the airflow is diverted through the dust filter and it is cleaned in no time. The dirt simply falls into the collection container or the inserted dust bag, and the Ventos regains its full suction power.



AUTOMATIC FILTER CLEANING – VENTOS AC-MODELS

The Automatic-Clean filter cleaning function of the Ventos AC offers added convenience. Thanks to an additional rotary knob, it is possible to set the intervals at which an automatically triggered air blast cleans the flat pleated filter. This enables long filter service life and ensures uninterrupted and continuous operation at full suction power.

TECHNICAL HIGHLIGHTS



CONTROL PANEL

With the Ventos series, the user always has all functions in view. The control panel allows infinitely variable regulation of the suction power.

In the case of the Ventos AC, the control panel also allows to set the interval for automatic filter cleaning.



AUTOMATIC START-UP

An integrated socket allows the connection of power tools (max. 2200 W).

The automatic start-up function switches the vacuum cleaner on when the tool is switched on, and the run-on function ensures that the suction hose is completely emptied after the tool is switched off.



PRINCIPLE OF ARRANGEMENT

This means that the accessories are always within reach. Power cable and suction hose can be spooled and stowed easily. A semicircular holder on the top, into which the suction tube can be inserted, allows the industrial vacuum cleaner to be carried comfortably by holding the suction tube securely in the recessed grip.

Ventos-Series



PRACTICAL

Handle with a holder for the suction tube for safe transport

COMFORTABLE

Socket outlet for power tools, with automatic start-up, automatic switch-off and overrun function

TIDY

Space-saving stowage of pipes, hose, cable and accessories

ROBUST

All-terrain chassis for mobility and high stability

SIMPLE

Drain screw for a problem-free draining of liquids after the sucking up of liquids

AS STANDARD

Extensive accessories to accomplish different cleaning tasks



Ventos 32 L/AC | 580020

► **ACCESSORIES** | page 102-103



EQUIPMENT

- Ventos PC: Push-Clean filter cleaning | Ventos AC: Automatic-Clean filter cleaning
- Wet and dry vacuuming
- integrated automatic on/off switch
- Mains connection of power tool (max. 2200 W)
- Container/filter bag volume sensor with LED display
- Level storage surface - for storing work materials



CHOOSE FROM TWO DIFFERENT
CONTAINER SIZES

MODEL	Ventos 32 L/PC	Ventos 42 L/PC	Ventos 32 L/AC	Ventos 42 L/AC
Ord.no.	580000	580040 NEW	580020	580060 NEW

TECHNICAL SPECIFICATIONS

Dust class	L	L	L	L
Filter cleaning	Manual	Manual	Automatic	Automatic
Volumetric flow rate turbine max l/min	4500	4500	4500	4500
Depression turbine max kPa mbar	25 250	25 250	25 250	25 250
Connection V ~ Hz A	230 1 50 16	230 1 50 16	230 1 50 16	230 1 50 16
Power consumption P _{nom} W	1200	1200	1200	1200
Container volume L	30	40	30	40
Filling volume water intake L	30	40	30	40
Sound pressure level at workplace db (A)	68.3	68.3	68.3	68.3
Protection class	IPx4	IPx4	IPx4	IPx4
Power supply cable m	7.5	7.5	7.5	7.5
Dimensions L x W x H mm	590 365 565	590 365 645	590 365 565	590 365 645
Weight kg	18.5	19	19.3	19.8

EQUIPMENT

Dust bag	Quantity Ord.no.	5 454511	5 454521	5 454511	5 454521
Disposal bag	Quantity Ord.no.	1 454551	1 454561	1 454551	1 454561
Folded filter	Dust class Ord.no.	L 457079	L 457079	L 457079	L 457079
Suction hose antistatic	m Ord.no.	4 (DN 32) 452825	4 (DN 32) 452825	4 (DN 32) 452825	4 (DN 32) 452825
Hand tube	Ord.no.	584031	584031	584031	584031
Extension tube	Quantity Ord.no.	2 584032	2 584032	2 584032	2 584032
Floor nozzle	Ord.no.	584035	584035	584035	584035
Brush nozzle	Ord.no.	584008	584008	584008	584008
Joint nozzle	Ord.no.	584023	584023	584023	584023
Tool adapter	Ord.no.	584112	584112	584112	584112

THE RIGHT EQUIPMENT FOR EVERY REQUIREMENT

Whether you need to clean hard-to-reach areas or use it on large surfaces: With the accessories included as standard, the Ventos-Series is already optimally equipped for the most common cleaning tasks. Our optionally available range of special accessories also meets the highest requirements and particularly demanding tasks. **Our accessories are compatible with all existing Ventos models.**



Dust bag

■ tear-resistant fleece filter bag for dry vacuuming

Ord.no.	454511	454521
Quantity	5	5
Filling volume Litres	30	40



Disposal bag

■ for Ventos PC and Ventos AC

Ord.no.	454551	454561
Quantity	5	5
Filling volume Litres	30	40



Folded filter

■ for Ventos PC and Ventos AC

Ord.no.	457079
Dust class	L
Dimensions L x W mm	240 140



Suction hose

■ antistatic

Ord.no.	452825
Dimensions L m	4 (DN32)
Connection Ø mm	45



Hand tube

■ with air slide

Ord.no.	584031
Dimensions L mm	320
Connection Ø mm	45 35



Extension tube

■ Galvanised steel

Ord.no.	584032
Dimensions L mm	2 x 500
Connection Ø mm	35



Floor nozzle

for wet and dry vacuuming

Ord.no.	584035
Dimensions L mm	360
Connection Ø mm	35



Brush nozzle

for simultaneous vacuuming and brushing

Ord.no.	584008
Brush Ø mm	70
Connection Ø mm	35

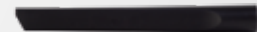

Joint nozzle

for use in narrow places

Ord.no.	584023
Dimensions L mm	300
Connection Ø mm	35



Tool adapter

for suction of power tools

Ord.no.	584112
Dimensions L mm	120
Connection Ø mm	45 35

USE OF POWER TOOLS

The tool adapter or the optionally available tool suction hose are compatible with almost all common power tool brands. Dust and flying chips are effectively extracted, which guarantees comfortable as well as dust-free working.

Tool connection: Ø 25 mm





Floor nozzle

- made of aluminium, light and robust
- with integrated brush and rubber strips

Ord.no.	584028
Dimensions L mm	450
Connection Ø mm	35



Turbo brush

- for the thorough cleaning of carpets
- with driven brush roller

Ord.no.	584024
Dimensions L mm	280
Connection Ø mm	35



Carpet nozzle

- for carpets and smooth surfaces
- Adaptable to the respective surface

Ord.no.	584018
Dimensions L mm	295
Connection Ø mm	35



Tool-Suction hose

for suction of power tools

Ord.no.	452828
Dimensions L m	4 (DN32)
Connection Ø mm	45 35



Upholstery nozzle

for cleaning textile surfaces

Ord.no.	584009
Dimensions L mm	145
Connection Ø mm	35



Wide nozzle

for use in narrow places

Ord.no.	584012
Dimensions L mm	250
Connection Ø mm	35



Universal brush nozzle

for simultaneous vacuuming and brushing

Ord.no.	584017
Dimensions L mm	230
Connection Ø mm	35



Suction brush

gentle pet care without tiresome shedding

Ord.no.	584020
Dimensions L mm	235
Connection Ø mm	35



Suction currycomb

removes gross impurities from animal skins

Ord.no.	584019
Dimensions L mm	240
Connection Ø mm	35



NEW



Folded filter Wet + Dry

- for Ventos PC and Ventos AC

Ord.no.	457120
Dust class	M, L
Dimensions L x W mm	240 140

ACCESSORIES FOR OLDER VENTOS MODELS



Dust bag

- for Ventos 20 E/L

Ord.no.	454400
Quantity	5
Filling volume Litres	20



Dust bag

- for Ventos 30 E/L

Ord.no.	454401
Quantity	5
Filling volume Litres	30



Filter

- for Ventos 20 E/L, Ventos 30 E/L

Ord.no.	454403
Dust class	L
Ø mm	280



KRÄNZLE HAND POWER SWEEPERS

BEST SWEEP-ACTION CLEANING RESULTS INSIDE AND OUT

Clean in passing: Kränzle's manual sweepers ensure that cleanliness is easily maintained in both indoor and outdoor areas - e.g. on paths, driveways or terraces - resulting in clean floor surfaces. Also for commercial use, on farms or in workshops as well as in the craft sector or for cleaning buildings, there are multiple applications for these devices.

TABLE OF CONTENTS

Colly 800	118-119
Kränzle 1+1	120-121

KEY INDUSTRIES





TECHNICAL HIGHLIGHTS



LONG CLEANING BRISTLES

Outside, the long bristles of smooth-running manual sweepers collect debris such as leaves, litter and other materials in the collection box. Indoors, they thoroughly remove dust and other particles.



INTEGRATED FREEWHEEL

Thanks to the integrated freewheel, the sweeping roller and side broom will turn sweeping material into the container.



EASY EMPTYING

The hopper made of impact resistant plastic can be used for emptying easily with the help of a practical handle and on the basis of its well thought-out construction.

Colly 800



Colly 800 | 50079

EQUIPMENT

- Integrated free-wheel
- Dustpan principle
- Large waste bin, volume 30 liters
- 2 infinitely height-adjustable side brushes





MODEL	Colly 800
Ord.no.	50079

TECHNICAL SPECIFICATIONS

Drive		Manual
Area sweeping capacity at 2.5 km/h	m ² /h	2000
Waste bin volume	Liter	30
Exhaust air filter	mm ²	2 x 6000
Dimensions/standing position	mm	750 400
Working width (with 2 side brushes)	mm	800
Drive wheels Ø	mm	300
Sweeper roller Ø	mm	254
Dimensions L x W x H	mm	980 850 390
Weight	kg	19



Kränzle 1+1



Kränzle 1+1 | 50077

EQUIPMENT

- Integrated free-wheel
- Dustpan principle
- large waste bin, volume 30 liters
- 1 infinitely height-adjustable side brush
- Height-adjustable main broom





MODEL	Kränzle 1+1
Ord.no.	50077

TECHNICAL SPECIFICATIONS

Drive		Manual
Area sweeping capacity at 2.5 km/h	m ² /h	1675
Waste bin volume	Liter	30
Dimensions/standing position	mm	1300 800
Working width (with 1 side brush)	mm	670
Drive wheels Ø	mm	285
Sweeper roller Ø	mm	250
Dimensions L x W x H	mm	1300 800 2060
Weight	kg	24



NOZZLE TABLE FLOW VOLUME

Nozzle-size	∅	20 / 2	30 / 3	40 / 4	50 / 5	60 / 6	70 / 7	80 / 8	90 / 9	100 / 10	110 / 11	120 / 12	130 / 13	140 / 14	150 / 15
0002 1502 2502	0.91	2.0	2.5	2.8	3.2	3.5	3.7	4.0	4.2	4.5	4.7	4.9	5.1	5.3	5.5
15025 25025	0.98	2.5	3.1	3.6	4.0	4.4	4.8	5.1	5.4	5.7	6.0	6.2	6.5	6.7	7.0
0003 1503 2503 4003	1.09	3.1	3.7	4.3	4.8	5.3	5.7	6.1	6.3	6.8	7.1	7.4	7.7	8.0	8.3
15035 25035	1.15	3.6	4.4	5.0	5.6	6.2	6.7	7.1	7.6	8.0	8.4	8.7	9.1	9.4	9.8
0004 1504 2504 4004	1.19	4.2	5.2	5.9	6.6	7.3	7.8	8.4	8.9	9.4	9.8	10.3	10.7	11.0	11.5
00045 15045 25045 40045	1.27	4.5	5.5	6.4	7.1	7.8	8.4	9.0	9.6	10.2	10.6	11.0	11.4	11.8	12.2
0005 1505 2505 4005	1.35	5.0	6.2	7.1	8.0	8.7	9.4	10.0	10.7	11.3	11.9	12.4	12.9	13.4	13.9
00055 15055 25055 40055	1.4	5.6	6.8	7.8	8.7	9.6	10.3	11.1	11.8	12.4	13.0	13.6	14.2	14.8	15.3
0006 1506 2506 4006	1.47	6.0	7.4	8.6	9.6	10.4	11.3	12.1	12.8	13.6	14.2	14.8	15.4	16.0	16.6
00065 15065 25065 40065	1.52	6.6	8.0	9.3	10.4	11.3	12.3	13.2	14.0	14.7	15.4	16.1	16.8	17.4	18.0
0007 1507 2507 4007	1.6	7.1	8.6	10.0	11.2	12.2	13.2	14.1	15.0	15.3	16.6	17.3	18.0	18.7	19.4
00075 15075 25075 40075	1.65	7.6	9.3	10.7	12.0	13.1	14.2	15.2	16.1	16.9	17.8	18.6	19.3	20.1	20.8
0008 1508 2508 4008	1.7	8.0	9.8	11.3	12.7	14.0	15.1	16.1	17.1	18.0	18.8	19.6	20.4	21.2	22.0
00085 15085 25085 40085	1.75	8.5	10.4	12.1	13.5	14.8	16.0	17.1	18.1	19.1	20.0	20.9	21.8	22.6	23.4
0009 1509 2509 4009	1.8	9.1	11.1	12.8	14.3	15.7	17.0	18.0	19.2	20.2	21.2	22.1	23.0	23.9	24.7
0010 1510 2510 4010	1.9	10.0	12.3	14.2	16.0	17.4	18.9	20.1	21.4	22.5	23.6	24.6	25.6	26.6	27.6
2511	2.6	11.2	13.7	15.9	17.7	19.4	21.0	22.4	23.8	25.1	26.3	27.5	28.6	29.7	30.7
2512	2.16	12.2	15.0	17.3	19.3	21.2	22.9	24.5	25.9	27.4	28.7	30.0	31.2	32.4	33.5

160 / 16	170 / 17	180 / 18	190 / 19	200 / 20	210 / 21	220 / 22	230 / 23	240 / 24	250 / 25	260 / 26	270 / 27	280 / 28	290 / 29	300 / 30	bar / MPa
5.7	5.9	6.0	6.2	6.4	6.6	6.7	6.8	6.9	7.0	7.1	7.3	7.4	7.5	7.6	l/min
7.2	7.4	7.6	7.9	8.1	8.3	8.5	8.6	8.8	9.0	9.2	9.4	9.5	9.7	9.9	l/min
8.6	8.9	9.1	9.3	9.5	9.7	9.9	10.1	10.3	10.5	10.6	11.2	11.4	11.6	11.8	l/min
10.1	10.4	10.7	11.0	11.3	11.6	11.8	12.1	12.4	12.6	12.9	13.1	13.3	13.6	13.8	l/min
11.9	12.2	12.6	12.9	13.3	13.6	13.9	14.2	14.5	14.8	15.1	15.4	15.7	16.0	16.3	l/min
12.6	13.0	13.4	13.8	14.2	14.6	15.0	15.3	15.6	15.9	16.2	16.7	17.1	17.4	17.7	l/min
14.3	14.7	15.1	15.5	15.9	16.3	16.7	17.1	17.5	17.9	18.2	18.6	18.9	19.2	19.6	l/min
15.8	16.3	16.7	17.1	17.5	17.9	18.3	18.7	19.1	19.5	19.9	20.4	20.7	21.1	21.5	l/min
17.1	17.6	18.1	18.6	19.1	19.6	20.1	20.5	20.9	21.3	21.7	22.3	22.7	23.1	23.5	l/min
18.7	19.4	19.9	20.4	20.9	21.4	21.9	22.4	22.9	23.4	23.8	24.1	24.6	25.0	25.5	l/min
20.0	20.6	21.2	21.8	22.4	22.9	23.4	23.9	24.4	24.9	25.4	25.9	26.4	26.8	27.3	l/min
21.5	22.2	22.8	23.4	24.0	24.6	25.2	25.8	26.3	26.8	27.3	27.9	28.4	28.9	29.4	l/min
22.8	23.5	24.2	24.8	25.4	26.0	26.6	27.2	27.8	28.4	29.0	29.5	30.1	30.6	31.1	l/min
24.1	24.9	25.6	26.3	27.0	27.7	28.3	28.9	29.5	30.1	30.7	31.4	31.9	32.5	33.1	l/min
25.5	26.3	27.1	27.8	28.5	29.2	29.9	30.6	31.3	31.9	32.5	33.2	33.8	34.4	35.0	l/min
28.5	29.4	30.2	31.0	31.8	32.6	33.4	34.1	34.9	35.6	36.3	36.9	37.6	38.3	38.9	l/min
31.7	32.7	33.6	34.6	35.5	36.3	37.2	38.0	38.8	39.6	40.4	41.2	42.0	42.7	43.4	l/min
34.6	35.7	36.7	37.7	38.7	39.6	40.6	41.5	42.4	43.2	44.1	44.9	45.8	46.6	47.4	l/min

Josef Kränzle GmbH & Co. KG

Rudolf-Diesel-Straße 20
89257 Illertissen (Germany)

phone: +49 (0) 7303 96 05-0

mail: sales@kraenzle.com

www.kraenzle.com

 youtube.com/kraenzleDE

1974 | 2024

50

YEARS

SUSTAINABLE
QUALITY

kraenzle[®]



Presented by your authorized Kränzle partner: